



**SC500TL**

**SC630TL**

**Power Conversion System (PCS)**

**Operation Manual**



# Content

---

<b>1</b>	<b>About this Manual.....</b>	<b>1</b>
1.1	Foreword.....	1
1.2	Validity.....	1
1.3	Content.....	1
1.4	Target Group.....	1
1.5	How to Use This Manual.....	2
1.6	Symbol Explanation.....	2
<b>2</b>	<b>Safety Instructions.....</b>	<b>4</b>
2.1	Intended Usage.....	4
2.2	Important Safety Instructions.....	5
2.3	During Operation.....	5
2.3.1	Manuals.....	5
2.3.2	Personnel.....	5
2.3.3	Markings on the PCS.....	6
2.3.4	Safety Warning Signs.....	6
2.3.5	Emergency Escape Route.....	6
2.3.6	Storage Battery Protection.....	6
2.3.7	Live Line Measurement.....	7
2.3.8	Measuring Instrument.....	7
2.3.9	LCD Screen Parameter Setting.....	7
2.3.10	ESD Protection.....	7
2.3.11	Moisture Protection.....	8
2.3.12	Maintenance and Service.....	8
2.3.13	Disposal of Waste.....	8
2.3.14	Others.....	8
<b>3</b>	<b>Product Description.....</b>	<b>10</b>
3.1	System Introduction.....	10
3.1.1	Development prospects.....	10
3.1.2	Introduction of energy storage converter.....	10
3.1.3	Micro-grid power generation system.....	10
3.2	PCS Features Introduction of energy storage converter.....	10
3.3	Product Appearance.....	11

3.4	Communication Solution.....	13
3.4.1	RS485 Communication.....	13
3.4.2	Ethernet Communication.....	13
3.4.3	Communication with BMS.....	14
3.5	Circuit Diagram.....	15
<b>4</b>	<b>PCS Start/Stop.....</b>	<b>16</b>
4.1	Operations on the DC circuit load switch.....	16
4.2	Starting the PCS.....	17
4.2.1	Inspection before PCS Start.....	17
4.2.2	Steps to Starting the PCS.....	17
4.3	Stopping the PCS.....	18
4.3.1	Normal Stop.....	18
4.3.2	PCS Stop when a fault occurs.....	18
<b>5</b>	<b>Operation Mode.....</b>	<b>19</b>
5.1	Basic Functions.....	19
5.2	Operation Status Description.....	20
5.3	Status Switch.....	20
5.4	Operation Mode.....	21
5.4.1	Grid-Connected Mode.....	21
5.4.2	VSG Mode.....	21
5.4.3	Mode Switching.....	22
<b>6</b>	<b>LCD Touch Screen Operation.....</b>	<b>23</b>
6.1	LCD Touch Screen.....	23
6.1.1	Location and Construction of LCD touch screen.....	23
6.1.2	Power Indicator.....	23
6.2	Default Screen.....	23
6.2.1	Initialization.....	23
6.2.2	Default Screen Introduction.....	24
6.2.3	Backlight and Screensaver.....	24
6.3	Overview of LCD Menu and Icon.....	24
6.3.1	Overview of Submenu and Icon.....	24
6.3.2	Page layout of Submenu.....	25
6.4	Entering Password.....	26
6.5	Date and Time Setting.....	27
6.6	Stop Control.....	27
6.7	Load Default.....	28

6.8	Firmware Version Checking .....	28
6.9	Communication Parameters.....	29
<b>7</b>	<b>Parameter setting and information check .....</b>	<b>32</b>
7.1	Log in WEB SERVER.....	32
7.2	Setting parameters.....	32
7.3	Information Viewing .....	43
<b>8</b>	<b>Converter Functions .....</b>	<b>44</b>
8.1	LVRT .....	44
8.2	HVRT.....	44
8.3	Protection Functions .....	45
<b>9</b>	<b>Routine Maintenance .....</b>	<b>48</b>
9.1	Safety Instructions.....	48
9.1.1	Safety Rules.....	48
9.1.2	Five Safety Rules.....	48
9.2	Maintenance and Interval.....	48
9.3	Filter Checking and Cleaning .....	50
9.4	Replacing Electrical Components.....	51
<b>10</b>	<b>Troubleshooting.....</b>	<b>52</b>
10.1	Fault Checking.....	52
10.2	Fault and Troubleshooting of LED .....	52
10.3	Fault and Troubleshooting on the LCD screen .....	53
10.4	Other Faults .....	55
<b>11</b>	<b>Appendix .....</b>	<b>56</b>
11.1	Technical Data.....	56
11.2	Quality Assurance .....	58
11.3	Contact Information.....	59



# 1 About this Manual

## 1.1 Foreword

Thank you for purchasing the SC500TL/SC630TL power conversion system (PCS) from Sungrow Power Supply Co., Ltd. We hope that the device will meet with your satisfaction when you use it. Your commands and feedbacks on the performance and function of the device are very important for our further improvement.

## 1.2 Validity

This Operation Manual is valid for the following device types:

- SC500TL/SC630TL

The SC500TL/SC630TL device is referred to as "PCS" hereinafter unless otherwise specified.

## 1.3 Content

This manual contains the following information:

- Safety Instructions
  - Safety instructions for operation and maintenance of the PCS.
- Product Description
  - System composition, PCS function and operation mode is described.
- Use
  - Introduce the PCS operation and use of human-machine interface (HMI) and Web Server.
- Routine Maintenance
  - Introduce the daily maintenance of the PCS and the replacement of certain accessories.
- Troubleshooting
  - Introduce the potential faults and troubleshooting of the PCS.
- Others

Technical data of the PCS, exclusion of liability and the way to contact Sungrow.

## 1.4 Target Group

This manual is aimed at technical personnel who are responsible for PCS operation and maintenance. Readers should have certain electrical knowledge and familiar with electrical principles and electrical components.

## 1.5 How to Use This Manual

Read this manual and other related documents carefully before any work on the PCS. Documents must be stored carefully and available at all times. Additional documents are also available to the users.

- Installation Manual (in the scope of delivery)
- Connection Requirements for Medium-voltage Transformers

All rights reserved including the pictures, markings and symbols used. Any reproduction or disclosure, even partially, of the contents of this manual is strictly forbidden without prior written authorization of Sungrow.

## 1.6 Symbol Explanation

This manual contains important safety and operational instructions that must be accurately understood and followed during the operation and maintenance of the equipment.

### DANGER

**DANGER indicates a hazard with a high level of risk which, if not avoided, will result in death or serious injury.**

### WARNING

**WARNING indicates a hazard with a medium level of risk which, if not avoided, could result in death or serious injury.**

### CAUTION

**CAUTION indicates a hazard with a low level of risk which, if not avoided, could result in minor or moderate injury.**

### NOTICE

**NOTICE indicates a situation which, if not avoided, could result in equipment or property damage.**





**NOTE indicates additional information, emphasized contents or tips to help you solve problems or save time.**

### Symbols on the PCS Body

The symbols below may be pasted on the electrical parts of the PCS. Make sure to read the following symbols and fully understand them before operating the device.



Symbols	Explanations
	Risk of electric shock!
	Hot surface!
	Connection point for earth conductor Protective conductor terminal

## 2 Safety Instructions

### 2.1 Intended Usage

SC500TL/SC630TL, researched and developed by Sungrow Power Supply Co., Ltd., is a PCS for energy storage system without transformer. It provides an interface for the grid and battery for storage system charging and discharging. Through step up by the external transformer, the PCS AC side can connect to the grid or load.

With IP21 protection rate, the PCS can be installed indoors only.

Through the external medium-voltage transformer, the AC output voltage of PCS will be raised to conform to parameters of local utility grid. Then the PCS can be connected to the grid. For specific technical requirements of transformer, please refer to the "Connection Requirements of Medium-Voltage Transformer".

The charging and discharging system with SC500TL/SC630TL is shown below:

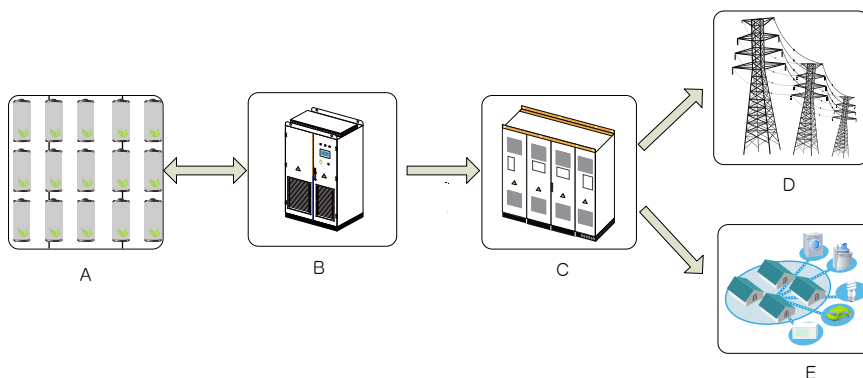

**Fig2-1** Energy storage system

No.	Name
A	Energy storage batteries (lead-acid battery, lithium battery and etc.)
B	SC500TL/SC630TL PCS
C	Medium-voltage transformer
D	Utility grid
E	Loads

#### **⚠ WARNING**

- **Installation described in this section must be strictly observed. Any other or additional installation other than the described installation is not permitted.**
- **Installation and connections other than the contents described in this section may lead to device damages and void warranty claims from Sungrow.**

## 2.2 Important Safety Instructions

This section introduces the safety instructions during installing or commissioning of the PCS. Read the safety instructions in this section before PCS operation. Please also respect all warnings, instructions, and cautions and respective chapter before operation.

### DANGER

#### **Shock Hazard!**

**Death resulting from burns and electric shock upon touching the PCS live components.**

- **Do not touch the live components of the PCS or the utility grid.**
- **Observe all safety regulations.**

### DANGER

#### **Shock hazards inside the PCS!**

- **Note and respect the warning labels in the product.**
- **Respect all safety instructions in this manual and other related document.**

### DANGER

#### **Electric shock or fire due to device damage or system fault!**

- **Visual check if there is device damage or other potential dangers before operation.**
- **Check if other external devices or circuit connections are safe.**
- **Operate the device only when it is safe to do so.**

### WARNING

**Follow the steps in this manual strictly to power the device after maintenance and troubleshooting.**

## 2.3 During Operation

### 2.3.1 Manuals

Very important information about the PCS operation is contained in this manual. All the descriptions in this manual, especially those safety-related items, must be complied with.

- Operate the PCS by strictly following the description in this manual. Device damage, personal injury or property loss may follow if otherwise.
- This manual and other related documents should be available for relevant persons at all times.

### 2.3.2 Personnel

- Only professional electrician or personnel with professional training can operate the PCS;

- Operator should be familiar with the construction and working principle of the whole energy storage system;
- Operator should be familiar with the PCS Operation Manual and Installation Manual;
- Operator should be familiar with the country/local specific standards.

### 2.3.3 Markings on the PCS

- PCS enclosure and interior contains important warning and safety information. Do not tear or damage it.
- Nameplates located in the back panel and inside the front door contain very important parameter information. Do not tear or damage them.

#### NOTICE

- **All safety instructions, warning labels and nameplate on the PCS body must be clearly visible;**
- **Replace the markings once they damaged or unclear.**

### 2.3.4 Safety Warning Signs

Please respect the followings during installation, daily maintenance or troubleshooting of the PCS:

- An obvious marking should be placed in the PCS upstream and downstream to keep the switch from accidental reconnection;
- A temporary warning sign or barrier must be posted around the operation area;
- Remove the door keys and keep them appropriately after maintenance or troubleshooting work is finished.

### 2.3.5 Emergency Escape Route

The emergency escape route is critical during an emergency situation.

- Keep the escape route clear and unblocked at all times.
- Never block or lock the emergency escape route in any form.

### 2.3.6 Storage Battery Protection

High Voltages exist between positive and negative polarities of the storage batteries for large-scale plant. Electrical shock or life risk may occur by accidental touch.

#### DANGER

**High voltages exist between the positive and negative polarities of the storage batteries!**

- **Ensure the PCS and storage batteries are completely disconnected during device maintenance.**
- **Place warning labels in the disconnection place to avoid accidental reconnection.**

### 2.3.7 Live Line Measurement

#### DANGER

**High voltages are present in the device. Death resulting from burning and electric shock upon touching the live components of the PCS. During live line measurement,**

- **use suitable protective equipment, for example dielectric gloves, and**
- **accompany by other persons.**

#### DANGER

**If the battery needs to be reconnected after the switch or circuit on battery output side is disconnected, ensure that:**

- **The PCS has been in the Stop state for at least 5 minutes.**
- **Voltages inside the device fall within safe range.**

#### DANGER

- **Never connect the battery while the PCS is operating.**
- **PCS fault or damage will be caused if the difference between the voltage of the connected battery and the DC voltage of the PCS is excessively large.**

### 2.3.8 Measuring Instrument

Appropriate measurement instruments are recommended during the electrical connection, commissioning and operation of the PCS.

#### WARNING

- **Use high-quality instruments that can meet the field requirements.**
- **Ensure the safety and correctness of instruments connection and use to avoid electric arc.**

### 2.3.9 LCD Screen Parameter Setting

Certain touch screen settable parameters are closely related to the PCS operation; therefore these parameters can only be set after reliable evaluation of the system and PCS.

#### WARNING

- **Improper parameter setting may affect the functionality of the PCS.**
- **Only qualified personnel with authorization can set the PCS parameter.**

### 2.3.10 ESD Protection

#### NOTICE

**PCS may be damaged irreversibly by electrostatic discharge (ESD) at its components.**

- **During the operation of the PCS, please observe all the ESD-related safety regulations, for example, wear antistatic wrist strap.**
- **Avoid unnecessary touch of the printed circuit board or other sensitive components!**

### 2.3.11 Moisture Protection

#### NOTICE

**Moisture can damage the PCS. For normal operation of the PCS, please respect the followings:**

- **Do not open the PCS doors when relative humidity is higher than 95%.**
- **Do not maintain or service the PCS in rainy or other bad days.**

### 2.3.12 Maintenance and Service

#### WARNING

**Wait at least 15 minutes after the PCS stops and then open the PCS front door to maintain or service.**

Before any service work, observe the followings.

- Ensure that the PCS will not be started accidentally.
- Verify that the PCS interior is discharged completely with a multimeter.
- Necessary ground and short circuit connect.
- Cover the adjacent electrical components with insulation cloth during operation.
- Ensure the clearness of the safety route during maintenance and service work.

### 2.3.13 Disposal of Waste

When the PCS is end of life, it cannot be disposed of together with household wastes. Please contact the local authorized collection point.

### 2.3.14 Others

#### WARNING

**Please observe country/local-specific standards and regulations.**

#### WARNING

- **Only maintain and service the device when it is voltage-free.**
- **Never work alone when servicing this device. Two persons are required until the PCS is properly shut down and de-energized.**

Other protection measures:

- Use suitable protective equipment (for example safety goggles, earplugs, dielectric gloves, insulating shoes) when maintaining or servicing the device.
- Emergency aid should be prepared beforehand since the PCS is always installed far away from the downtown area.
- Every possible auxiliary method should be taken to ensure the safety of personnel and device.



- All the pictures and descriptions in this manual apply to the standard configuration of the PCS. The actual product you receive may differ. Should you have any specific requirements, please inform us.
- This manual may not cover all possible situations. Should a specific problem occur that is not explained in this manual, please contact Sungrow.

## 3 Product Description

### 3.1 System Introduction

#### 3.1.1 Development prospects

Electric power system consists of the following six parts: development, generation, transmission, distribution, consumption and storage. Among which, the energy storage system is important to realize the following functions: demand side energy management, substation grid support, load balance, renewable energy application etc.

#### 3.1.2 Introduction of energy storage converter

The power conversion system (PCS) of the SC500TL/SC630TL serials can be applied in the grid-connection system to implement frequency regulation, peak shaving, active power storage, reactive power support, energy transfer, and new energy consumption. In addition, the PCS can also perform off-grid black start and support power supply to supply power for the load.

#### 3.1.3 Micro-grid power generation system

Smart grid system with PCSs for energy storage system is shown in Fig3-1.

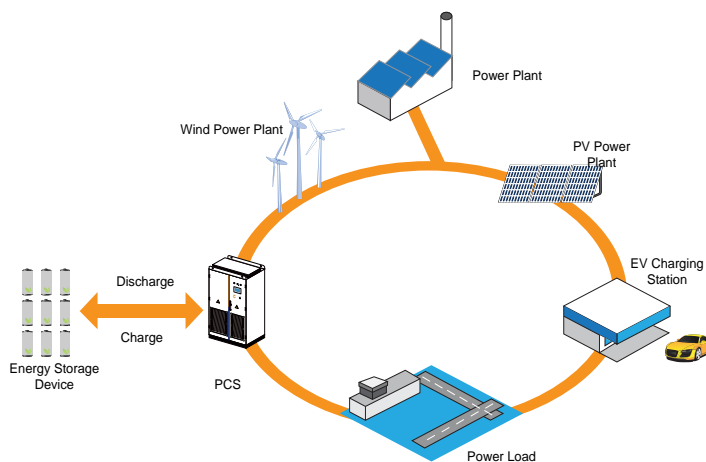

**Fig3-1** Smart grid and energy storage system

### 3.2 PCS Features Introduction of energy storage converter

SC500TL/SC630TL PCS for energy storage system adopts the advanced digital control technology to optimize the control function and improve the system reliability. It is applicable for various battery charging and discharging situations. With module construction design, it is convenient for installation and maintenance. The major features are shown below:

- Grid dispatches; RS485, CAN and Ethernet communication
- Bi-direction inversion for storage battery charging and discharging
- Three-level topology with higher conversion efficiency



- Diverse grid-connection operation modes: constant current charging & discharging, constant voltage charging & discharging, constant power charging & discharging (DC), constant power charging & discharging (AC).
- Off-grid black start function and establishes backup power support.
- With VSG function, and has preferable redundancy expansion capacity
- Compatible with various batteries: lithium battery, lead-acid battery, flow battery and super-capacitor
- Perfect communication and protection functions such as reverse connection protection, short circuit protection, and insulation impedance detection
- LVRT, reactive power compensation and active power adjustment
- Continuous full power operation at -30°C~+65°C (>55°C derating).
- Reliable and continuous operation in high-altitude harsh environment
- Heating and dehumidifying (optional)

The power conversion system SC500TL/SC630TL supports two AC voltages levels: 360V and 400V. AC 360V is the default voltage and corresponds to a rated power of 500KW, while the AC voltage of 400V corresponds to a rated power of 630KW. The voltage level is 360V by in default this manual unless otherwise specified.

### 3.3 Product Appearance

The appearance and external components of the PCS is shown below:

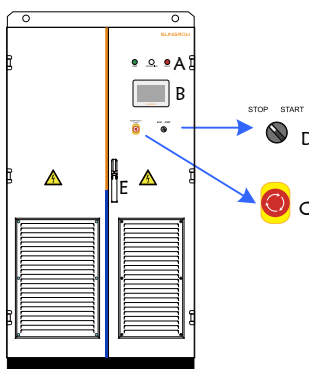

**Fig3-2** PCS appearance

Item	Name	Description
A	LED indicators	POWER, OPERATION and FAULT
B	LCD touch screen	Display basic electrical data
C	Emergency stop button	Stop the PCS in emergency by pressing this button down
D	Start/Stop button	Start/Stop the PCS
E	Lock	A lock to open and close the PCS front door



### LED indicators

There are three LEDs at the upper left side of the LCD: POWER indicates the power is on; OPERATION indicates the operation of the PCS; FAULT indicates a fault condition.

You can get the PCS operation state through these LEDs and control the PCS by the LCD touch screen. See the following table for the description of the LED indicators.

LED	Color	Description
POWER	Green	Control the circuit power supply; LED is on when DC side has power for 5min, LED is on immediately when the AC side has power or both the AC and DC side have power
OPERATION	Green	PCS operates normally
	White	PCS is in the standby state
FAULT	Red	A fault occurs and has not been removed. The LED will be off automatically when the fault is cleared.

Possible LED combinations and the meaning are listed in the following table:

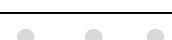
LED status	Description
 POWER OPERATION FAULT	"POWER" LED is on PCS normal power supply, no charging or discharging
 POWER OPERATION FAULT	"POWER" is on "OPERATION" is on AC and DC side parameters meet the requirements. PCS operates normally
 POWER OPERATION FAULT	"POWER" is on "FAULT" is on A fault occurs and not removed yet.
 POWER OPERATION FAULT	All LEDs are off PCS is disconnected from the power supply, no power supply

### LCD touch screen

LCD screen displays the operational information of the PCS and performs certain control functions

### Emergency Stop Button

PCS will be disconnected from the grid when pressing down the emergency stop button in emergency situation or fault condition.

#### WARNING

##### Electrical shock hazards!

- **The pressing of the emergency stop button in no way implies that no voltage is present in the AC and DC connection terminals inside the PCS.**
- **Lethal voltages are present inside the PCS!**

**WARNING**

**Use the emergency stop button to stop the PCS only in a time of emergency. Improper use of the emergency stop button may lead to PCS damages. Use of the emergency stop button under load will bring great stress to PCS related components. Frequent use will damage the button.**

When you push this button, the PCS AC side will disconnect from the grid immediately and the emergency button is locked.

You can restart the PCS by rotating the button clockwise to unlock it. Connect the grid and then the PCS will be restarted through the Web server or LCD touch screen.

**Start/Stop button**

This button is used to control the startup and stopping of the PCS. When the switch is turned to START, you can give your instructions through the Web server or LCD; otherwise, the PCS will be in the stop state.

When the switch is turned to STOP, a stop command is sent to the DSP controller to switch the PCS to the stop state.

### 3.4 Communication Solution

#### 3.4.1 RS485 Communication

PCS communicates with the PC through RS485/RS232 convertor. SolarInfo SC can be adapted to monitor the communication.

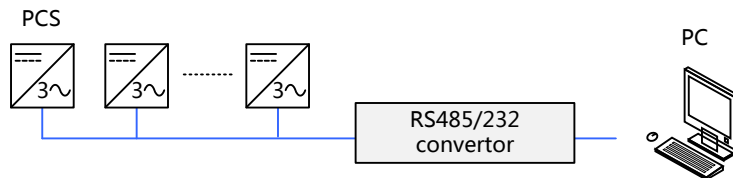

**Fig3-3** PC monitors through RS485

#### 3.4.2 Ethernet Communication

Besides the standard RS485 communication, PCS also provides the optional Ethernet communication. PCS supports the MODBUS TCP/RTU and IEC 104 protocol. If you have doubts about the communication solution, please contact Sungrow.

- Single PCS communication

For communication of a single PCS, connect the PCS RJ45 port to PC RJ45 port directly by a network cable. SolarInfo SC can be used to monitor the communication.



**Fig3-4** Ethernet communication for a single PCS

- Multiple PCSs communication

If there is more than one PCS, the Ethernet switch is required for communication. SolarInfo SC is used to monitor the communication.

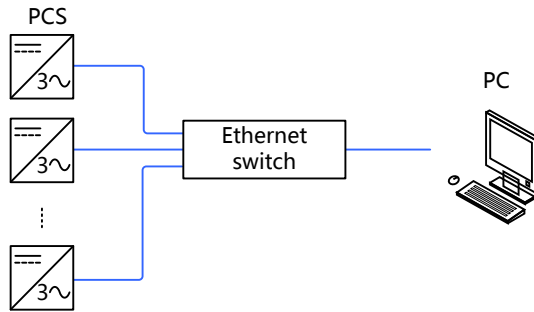

**Fig3-5** Ethernet communication for multiple PCSs

### 3.4.3 Communication with BMS

PCS can communicate with battery management system (BMS) to monitor the state of the battery and protect the battery according to the battery state. Communication supports the CAN and RS485 methods.

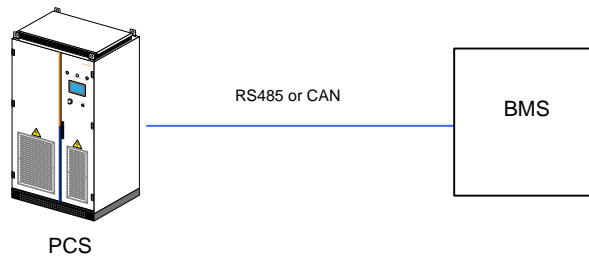

**Fig3-6** PCS communicates with BMS

### 3.5 Circuit Diagram

PCS realizes rectification and inversion through 3-phase half bridge conversion. The rectified output feeds to the storage batteries through EMC filter. The inverted output turns to sine-wave voltage through LC filter and then feeds to the grid after step-up by 3-phase transformer. The circuit diagram is shown in Fig.3-7.

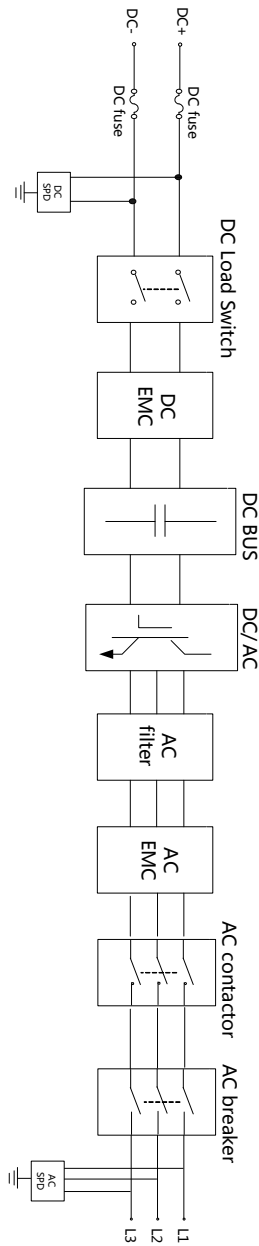
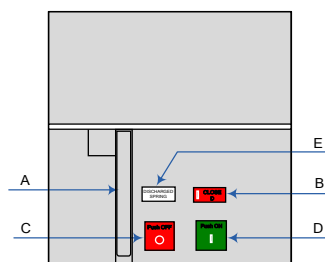

**Fig3-7** PCS circuit diagram

## 4 PCS Start/Stop

### 4.1 Operations on the DC circuit load switch

This converter is equipped with electrically-controlled load switch on the DC and AC sides. The appearance of the circuit load switch panels are shown in the figure below.



**Fig4-1** DC load switches

Item	Name	Description
A	Manual energy storage handle	When the circuit load switch has no energy, you can manually store energy through this button.
B	Circuit load switch state indicator	Display the present state of the circuit load switch, OPEN or CLOSED
C	Push OFF button	The load switch is switched off when this button is pressed
D	Push ON button	The load switch is switched on when this button is pressed
E	Energy storage state indicator	Display the present energy storage state, CHARGED SPRING or DISCHARGE SPRING

Load switch operation instructions:

- Switch on

Press the Push ON button on the load switch panel to switch on the load switch.

Before switching on the load switch, you need to check if the energy storage state displayed on the panel is CHARGED SPRING. If the state is DISCHARGED SPRING, you need to store the energy manually by turning the manual energy storage handle down until the load switch panel displays CHARGED SPRING.

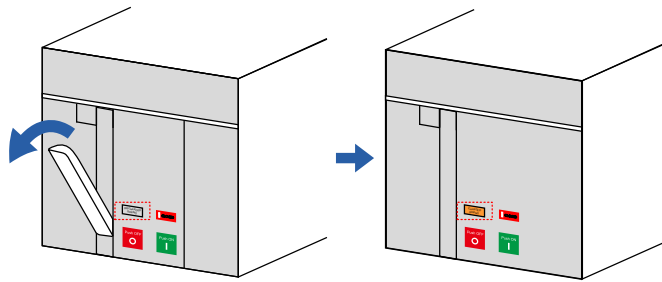

After the load switch is switched on, the load switch panel displays CLOSED.

- Switch off

Press the Push OFF button on the load switch panel to switch off the load switch.

After the load switch is switched off, the load switch panel displays OPEN.

## 4.2 Starting the PCS

### 4.2.1 Inspection before PCS Start

After the maintenance or service work, you may start the PCS. Inspect the following requirement before starting the PCS:

- All connections are done by strictly following the installation manual and circuit diagram.
- The protection cover inside the device has been installed securely.
- The AC side circuit breaker has been disconnected, and the DC load switch is open, that is, in the "OFF" position.
- The cabinet door is closed and the key is removed and stored by appointed personnel.
- The emergency stop button is released and the Start/Stop button is in Start position.
- Measure the DC and AC voltage with multimeter to check if they fulfill the PCS startup conditions and there is no overvoltage hazard.

#### **! WARNING**

**After longtime storage, a thorough and professional test is necessary before starting the PCS.**

### 4.2.2 Steps to Starting the PCS

When the abovementioned conditions are fulfilled, proceed as follows to start the PCS:

1. The storage battery side and grid side are connected correctly
2. Turn the PCS AC breaker to the ON position
3. PCS starts according to the dispatch instructions

After startup, PCS will automatically check if the AC and DC voltage and other parameters meet the operation requirements. If both the DC and AC parameters meet the requirements and the working instruction is received, PCS will automatically enter the Run mode and operate normally.

**WARNING**

- **PCS needs no manual control in daily operation.**
- **Keep the door closed and locked and store the keys of the door by appointed personnel during normal operation.**

### 4.3 Stopping the PCS

PCS stops during normal maintenance and service work or when a fault occurs.

#### 4.3.1 Normal Stop

Proceed as follows to stop the PCS during normal maintenance and service work:

1. Stop the PCS via the stop instruction on the LCD panel or the WEB interface
2. Open the PCS cabinet door
3. Rotate the PCS AC side circuit breaker to the "OFF" position
4. Disconnect the PCS downstream switches
5. Disconnect the PCS upstream switches
6. Disconnect the external power supply if the PCS is in external power supply mode
7. PCS stops

**WARNING**

**During normal operation, disconnection of the switches is strictly forbidden. Otherwise, arc may follow and the switch or even the PCS will be damaged.**

#### 4.3.2 PCS Stop when a fault occurs

Proceed as follows to stop the PCS when a fault or emergency occurs:

1. Push the emergency stop button or turn the Start/Stop button to the Stop position
2. Open the PCS cabinet door
3. Turn the PCS AC breaker to the OFF position
4. Disconnect the PCS downstream switches
5. Disconnect the PCS upstream switches
6. Disconnect the external power supply if the PCS is in external power supply mode
7. PCS stops

**WARNING**

- **Use the emergency stop button only when emergency or a fault occurs. Under normal conditions, stop the PCS by perform the stop command in the Web server interface or LCD screen.**
- **Push the emergency stop button directly in times of crisis to ensure timely response.**



## 5 Operation Mode

### 5.1 Basic Functions

The converter SC500TL/SC630TL has the following functions:

- Grid-connection operation function

The converter has sound grid-connection operation function and can flexibly control charging and discharging of different batteries. Charging/discharging mode and charging/discharging instruction are set via the PC or user interface. The specific on-grid charging and discharging modes are as follows:

The charging mode includes: constant power charging (DC), constant power charging (AC), constant voltage charging, and constant current charging.

The discharging mode includes: constant power discharging (DC), constant power discharging (AC), constant voltage discharging, and constant current discharging.

The grid-connection operation mode can well adapt to application scenarios such as peak shaving, frequency regulation, peak load shifting, smooth grid connection of new energy, and the like.

- Independent inversion function (VF)

The converter can perform black start in the off-grid state by using the independent inversion function (VF), and can establish AC voltage source with stable voltage amplitude and frequency to electrically support the load. Independent inversion voltage instruction and frequency instruction are set via the PC or user interface.

The independent inversion function can provide power supply support to keep the system stable in remote area, island, commercial micro grid, and other scenarios. In addition, the converter can be used as a standby power source to ensure power supply on important occasions or for important device.

- VSG function

VSG function includes two functions: on-grid operation and off-grid operation. During normal on-grid operation, the converter can regulate the grid-connected active power and reactive power by activating the VSG function. During off-grid operation, the converter can activate the VSG function to establish an AC voltage source to supply power to the load. In this case, the amplitude and frequency of the AC voltage source are automatically adjusted within a certain range as per the load attributes.

The VSG function has a commanding advantage in commercial micro grid with multiple kinds of energies. Particularly, in the micro grid with more rotating equipment such as a diesel engine, the VSG function can stabilize the system operation well.

- Reactive power control

In the on-grid operation mode, the PCS can control grid-connected reactive power by means of power factor and reactive power ratio control. In the VSG on-grid operation mode, the grid-connected reactive power can be controlled by means of reactive power instruction regulation and voltage instruction regulation.

## 5.2 Operation Status Description

The PCS SC500TL/SC630TL can be in the state such as "stop", "standby", "running", "emergency stop", and "fault".

### Stop

When no instruction operation or scheduling is performed on the converter, the system is in the stop state after initial stop.

When no fault, alarm, or other abnormal status exists, the converter receives the operation instruction and scheduling from the Web Server or PC in the stop mode. The converter switches to the operation mode from the stop mode when running requirements are met.

During running, if the converter receives the stop instruction or turns the Start/Stop button to the "STOP" position manually, it turns to the stop state from the running state.

### Standby

The converter can switch from the stop or grid-connected mode to the standby mode after receiving the standby instruction and scheduling from the Web Server or PC. In the standby state, the AC and DC switches of the converter are closed, and the system is in the hot standby state. After receiving an operation instruction and scheduling from the touchscreen, WEB interface, or PC, the converter can quickly enter the corresponding state.

#### NOTICE

**The normal operation condition of the converter is fault-free state.**

### Grid-connected mode

The grid-connected mode includes charging mode and discharging mode.

In the grid-connected mode, the converter can regulate power quality and control reactive power.

### Emergency stop

When the PCS is stopped by pressing down the emergency stop button, the AC side circuit breaker trips, and the PCS is disconnected from the grid. Before restarting the PCS, the emergency stop button needs to be released, and the AC circuit breaker needs to recover to the close state.

### Fault

When faults occur in the energy storage system, the converter stops operation and immediately disconnects the AC and DC side main switch to disconnect the main circuit of the device from the battery, grid, and load.

In this case, the system continuously monitors fault to ensure whether the it is removed. If the fault still exists, systems hold the fault state; and if the fault is removed, the system will automatically recover after a period of time. If the manual fault recovery function is activated, the fault state is not removed until the user operate the start/stop button or the emergency stop button manually.

## 5.3 Status Switch

In the **initialization** status, the PCS control system will finish self-detection to verify the completeness of the control and sensor system. When the monitor and protection functions are normal, PCS enters into the **OFF** status, during which PCS locks the IGBT pulse and disconnects

the AC/DC contactors. During the **Standby** status, PCS locks the IGBT pulse but connects the DC load switch and contactor and the PCS is in hot standby state.

To switch among different status, conditions in Fig.5-1 should be fulfilled.

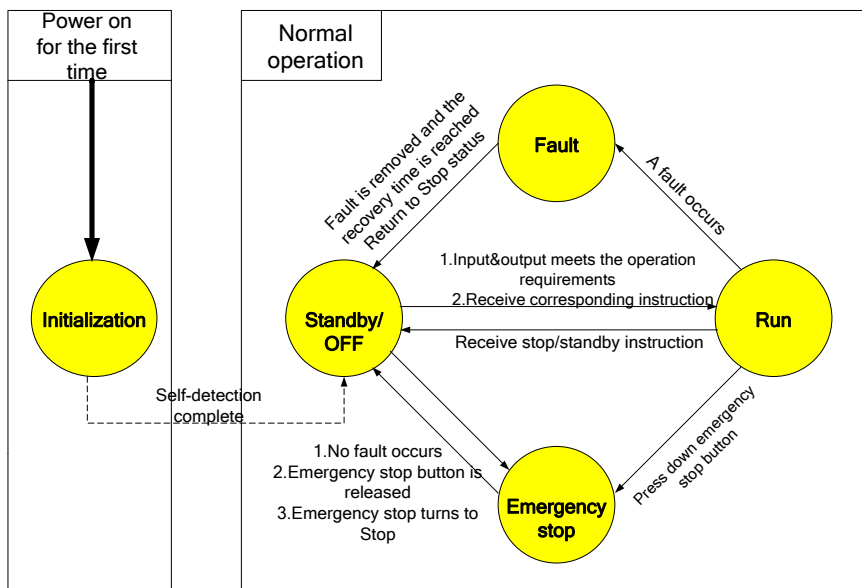

Fig5-1 Operation status switch

## 5.4 Operation Mode

### 5.4.1 Grid-Connected Mode

In the grid-connected mode, the converter can achieve the charging and discharging functions.

- The charging includes constant power charging (DC), constant power charging (AC), constant voltage charging, and constant current charging.
- The discharging includes constant power discharging (DC), constant power discharging (AC), constant voltage discharging, and constant current discharging.

### 5.4.2 VSG Mode

VSG (Virtual Synchronous Generator) control combines the converter control and synchronous generator control. It borrows the control methods of ordinary converter and conventional synchronous generator in terms of control policy. From the perspective of external input and output, the converter is equivalent to a synchronous generator. Essentially, VSG frequency droop control is controlling active power output based on a specific droop slope according to frequency changes; and VSG voltage droop control is controlling reactive power output based on a specific droop slope according to voltage changes. Running parameters that can be set in the VSG mode include output voltage set value, output frequency set value, active power setting, reactive power setting, frequency droop factor, and voltage droop factor.

The VSG mode can be set via the PC interface or WEB SERVER. The VSG mode has two operation states: on-grid state and off-grid state.

In the on-grid state, the converter automatically detects grid voltage signals, and performs operations synchronous with the grid. The on-grid active power and reactive power can be

adjusted via active power setting and reactive setting respectively.

In the off-grid state, the converter connects the AC contactor to output AC voltage and create a voltage source within a specific frequency range, so as to supply power for the load. In the off-grid state, the amplitude and frequency of the output voltage with no load can be set by setting the output voltage set value and output frequency set value.

#### NOTICE

- **The converter responds to VSG mode instructions only in the stop state not the standby state. The condition under which the converter can operate normally is the protection function is normal, and the voltage on the battery end falls within the set range.**
- **Before on-grid operation in the VSG mode, set the output voltage set value to be consistent with the grid voltage, and set the output frequency set value to be consistent with the grid frequency! Enable the VSG mode after setting the running parameters.**
- **During on-grid operation in the VSG mode, it is specified that positive active power set value indicates the converters generates active power, negative value indicates the converter absorbs active power, positive reactive power set value indicates the converter generates capacitive reactive power, and the negative reactive power set value indicates the converter generative inductive reactive power.**
- **During on-grid operation in the VSG mode, when the grid frequency is the same as the output frequency set value, the on-grid active power is equal to the set secondary frequency modulation value; and when the grid voltage is the same as the output voltage set vale, the on-grid reactive power is equal to the reactive power set value. During actual on-grid operation, the fluctuation of grid frequency and voltage will cause on-grid frequency fluctuation within a reasonable range, which is normal.**

### 5.4.3 Mode Switching

In the grid-connected mode, the PCS can directly switch between charging state and discharging state without a need of a middle transition state.

## 6 LCD Touch Screen Operation

### 6.1 LCD Touch Screen

#### 6.1.1 Location and Construction of LCD touch screen

The LCD touch screen, located at the eye-level in the front side of the PCS, is used to view the data and set related parameters.

The LCD consists of two parts as shown in the following figure. The LEDs indicate the present working state of the PCS and the screen. You may check and set related parameters by touching the LCD internal icons.

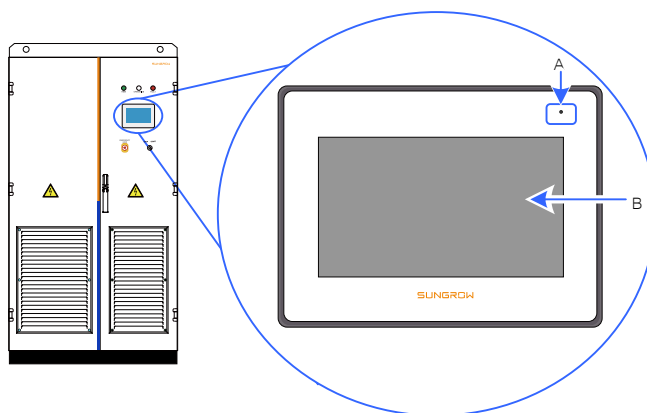

**Fig6-1** Location and appearance of the LCD display

Item	Description
A	Power indicator
B	Data display and operation area



For user's convenience, there are a large number of pictures about the LCD interface in this chapter. The parameters and other details in those pictures are indicative only. The actual product you receive may differ.

#### 6.1.2 Power Indicator

If the LCD screen is energized, the power supply indicator will be on.

### 6.2 Default Screen

Menu interface in this chapter is indicative only.

#### 6.2.1 Initialization

The LCD is initialized when PCS is energized and the initialization interface will appear



### Initialization

Appears every time the PCS is energized. After initialization, the default screen follows.

## 6.2.2 Default Screen Introduction

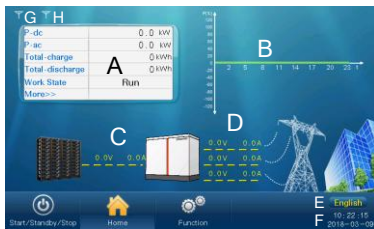

Item	Description
A	Displays the current DC power, AC power, total charging amount, total discharging amount, the real-time operation mode and state, and statuses of access control, smoke sensor, and leakage current
B	Today's charge and discharge power curve to indicate the power percentage (power value divides the PCS nominal power value).
C	DC side voltage and current
D	AC side line voltage and phase current
E	Language bar, showing the operating language of the current software
F	Present date and time
G	Strength of the PCS internal communication
H	Strength of communication between the PCS and PC or background monitor device

For the sake of description, the default screen mentioned hereinafter refers to this screen. Accessing to submenus and operations start from the default screen.

### WARNING

**LCD screen contains lots of parameters pertinent to the PCS operation. All parameter configurations must be done by appointed personnel. DO NOT modify any parameters before you fully understand this manual or consult the staff from Sungrow.**

## 6.2.3 Backlight and Screensaver

If there is no operation to the LCD screen for 5 minutes, screen will go out. Activate the backlight by tapping the screen the screen will return to the default screen.

## 6.3 Overview of LCD Menu and Icon

### 6.3.1 Overview of Submenu and Icon

User can operate on the from the LCD touch screen. There are three main buttons on the lower left side of the screen.

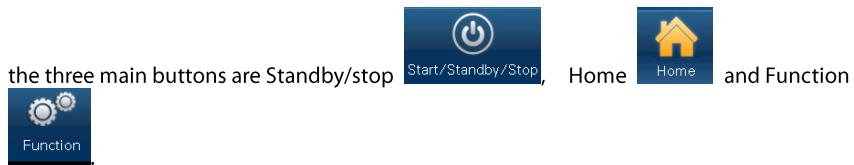

The logical structures of these menus and icons are shown below:

Main menu	1 <sup>st</sup> sub-menu	2 <sup>nd</sup> sub-menu	3 <sup>rd</sup> sub-menu
Start/Standby/Stop	Start		
	Standby		
	Stop		
Home			
Function	Start/Standby/Stop	Start	Enter / Cancel
		Standby	Enter / Cancel
		Stop	Enter / Cancel
	His-data		
	Set parameters	Sys-parameters	Language & Firmware version
			Time
			Load default
		Com-parameters	Serial port param
			Network param

### 6.3.2 Page layout of Submenu

All pages except home page follow this layout shown as below



No	Description
A	Title bar Top line shows the current strength of communication. The left side of the following line shows the name of current page; the right side

No	Description
	shows current date and time.
B	Data display or set area.
C	The left side is the three icon of main menu; the right side is the back button, tap it to return to the upper level.

For the sake of convenience, this manual will use the name of the menu with double quotes to

explain the operation of the corresponding menu. For example, when the  is mentioned, the corresponding description is "set-parameter".

## 6.4 Entering Password

Converter parameters are protected by password. User can enter into the "Set-parameter" sub-menu only after entering the correct password. Proceed as follows to enter the password:

**Step1** Tap "Function" from the default menu;

**Step2** Tap "Set-parameter" and the password entering window pops out;

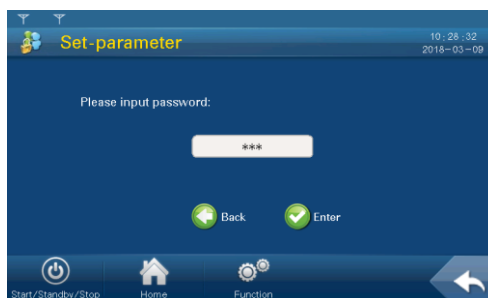

**Step3** Tap the white edit box and a keypad pops out.

**Step4** Enter the password through the keypad.

Button	Function
←	backspace key, delete the digit input
Clr	clear the digitals input
Esc	escape and close the keypad
Enter	confirm the password input
Max./Min.	the maximum and minimum value can be input; digital outside this range is invalid



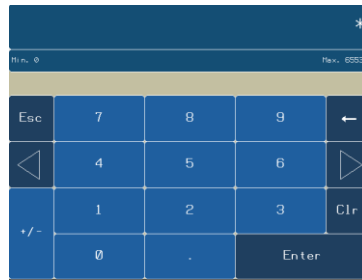

If the input password is 1111, user can enter into the normal parameter setting page and set the system parameters, running parameters, protection parameters and communication parameters.

**Step5** Press "Enter" to confirm the password input.

**Step6** If the password is incorrect, an "Error password" window will appear. Tap "Enter" and re-enter the password.

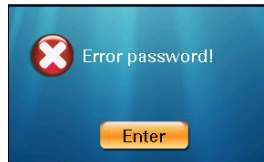

## 6.5 Date and Time Setting

**Step1** Tap "Function" from the default menu;

**Step2** Tap "Set-parameter"

**Step3** Tap "Sys-parameter" after entering the correct password;

**Step4** Tap "Time" and enter into the time sub-menu;

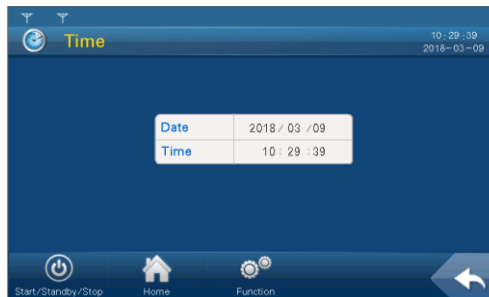

**Step5** Set the "Year", "Month", "Date", "Hour", "Minute" and "Second". Tap the corresponding cell and the keypad will appear;

**Step6** Set the time and date by tapping the keypad and confirm setting by tapping "Enter".

## 6.6 Stop Control



Normally, when the operating conditions of the converter are satisfied, the system will operate automatically without human interference and control.

- Tap "Standby/Stop" on the default page and enter the standby/stop page.



By tapping the stop button, the converter can stop at the same time.

A confirm operation interface will appear after tapping the corresponding buttons. The instruction is effective after confirmation; cancel the operation by tapping "Cancel".

## 6.7 Load Default

Proceed as follows to perform the load default:

- Step1** Tap "Function" from the default menu;
- Step2** Tap "Set-parameter";
- Step3** Tap "Sys-parameter" after entering the correct password;
- Step4** Tap "Load default" and the password inputting window appears;

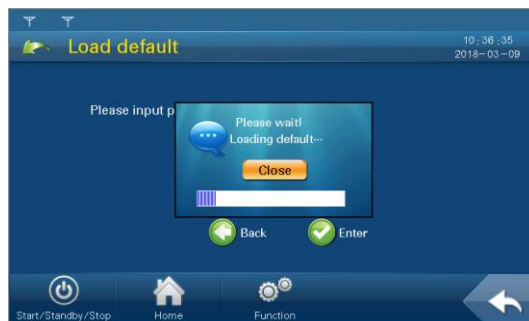

The password is "1111". The system will be reset after entering the password.

## 6.8 Firmware Version Checking

User can view the firmware version of LCD and DSP as follows:

- Step1** Tap "Function" from the default menu;
- Step2** Tap "Set-parameter";
- Step3** Tap "Sys-parameter" after entering the correct password;
- Step4** Tap "Language & Firmware Ver." and enter into the language and firmware version sub-menu;



**Step5** The firmware version of LCD and DSP is shown at the bottom of the page.

## 6.9 Communication Parameters

### WARNING

**Improper communication parameter configuration may lead to communication failure!  
Follow strictly the instructions of the plant staff to configure the communication parameters.**

There are the RS485 communication and Network communication. User can set the communication address and protocol through the LCD screen when the hardware connection is complete and the device is energized.

Proceed as follows to set the communication parameters:

- Step1** Tap "Function" from the default menu;
- Step2** Tap "Set-parameter";
- Step3** Tap "Com-parameter" after entering the correct password.



### Device Address Setting

Tap "Address" to enter the address setting interface.

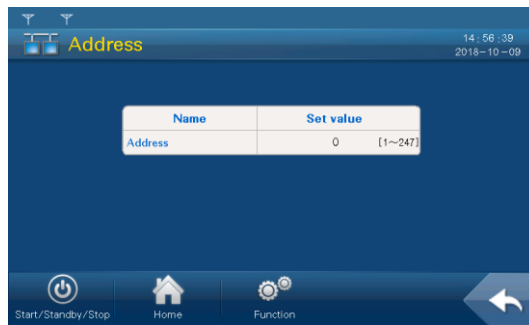

Set the address according to the effective parameter range on the LCD.

The device address is allocated by the plant staff in advance. When multiple devices communicate at the same time, each device should have a different address. Enter the device address via the pop-up keypad.

### Serial Port Parameter Setting

Tap "Serial port param" to enter the parameter setting interface.



Set the parameter according to the effective parameter range on the LCD.

The Baud rate is determined according to on-site communication manner. Select the Baud rate from the pull-down list.

### Network Parameter Setting

Tap "Network param" to enter the parameter setting interface.

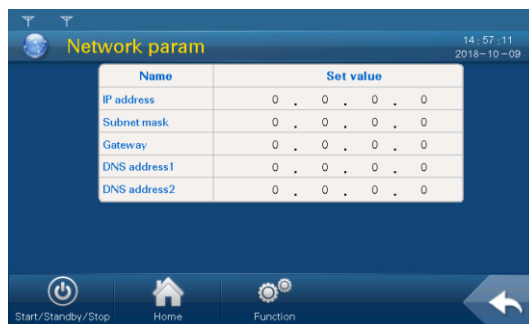

Parameters related to the Ethernet communication need to be set. The DNS address 1 and the DNS address 2 can be set to the default values. Other parameters are allocated by the plant staff in advance.

Enter the parameters via the pop-up keypad.

## 7 Parameter setting and information check

This chapter explains how to use the WEB SERVER to set the converter operating parameters, protection parameters, and other related information.

### 7.1 Log in WEB SERVER

- Step1** Set the IP address of the converter on the LCD screen referring to 6.9 Communication Parameters.
- Step2** Refer to the converter installation manual. Connect the two ends of the communication cable to the network ports of the converter and the upper computer.
- Step3** Enter the IP address set in step 1 in the browser address bar of the host computer to enter the WEB SERVER login interface.

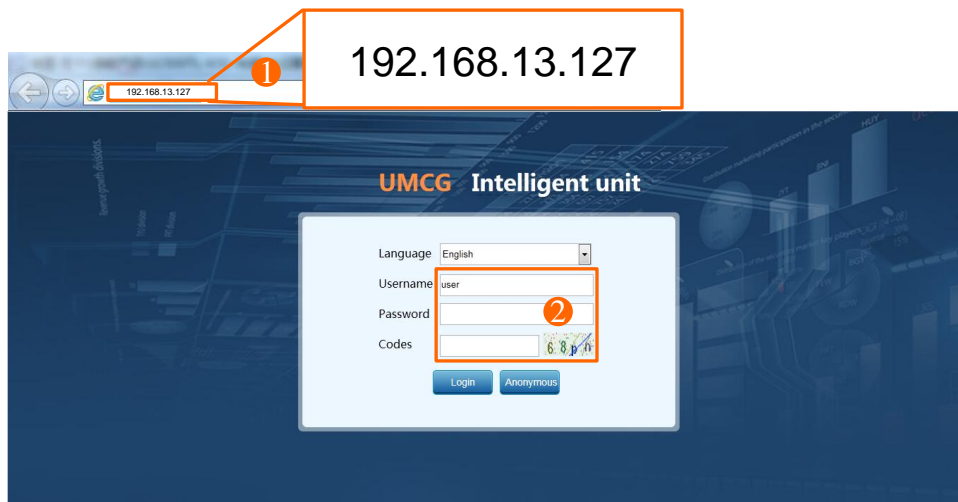

- "192.168.13.127" in the figure is set for illustration only. Please refer to the actual situation.
- The user's default password is "sglogger". If the password is incorrect, please contact SUNGROW.

- Step4** Enter the user name and password to enter the WEB SERVER main interface.

### 7.2 Setting parameters

After entering the WEB SERVER interface, click ① "Device Monitoring" → ② click "Parameter Setting" → ③ check the parameter value to be modified (take [Work Mode Setting] as an example) → ④ Enter the parameters that need to be changed. in the "Setting Value" column ⑤ Click "Batch Setup" or "Single Setup" to confirm the setting value in the pop-up window (or click "Parameter Read Back" to restore the previous settings values).

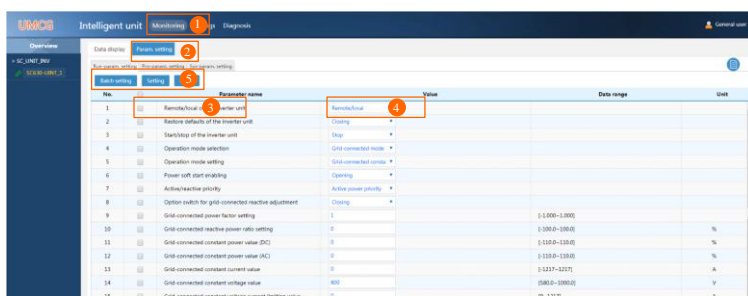

**NOTICE**

- Restart the UMCG device after setting any parameters with the O&M permission.
- During the independent operation of the off-grid independent converter, during the parameter setting process of the WEB SERVER, because the DSP starts to be in the unpowered state, the WEB SERVER parameter will be fed back to prompt the setting failure information. This is the normal logic of the off-grid black boot process. The converter will automatically perform the independent converter black start function. After the precharge logic is executed, the DSP will supply power normally, and the converter will establish the AC voltage normally.
- The VSG off-grid operation process is similar to the above.

Run-parameter setting range

Parameter name	Data range		Unit
	SC500TL	SC630TL	
Remote / local of the converter unit	-		
Restore defaults of the converter unit	-		
Start / stop of the converter unit	-		
Operation mode selection	-		
Operation mode setting	-		
Power soft start enabling	-		
Active / reactive priority	-		
Option switch for grid-connected reactive adjustment	-		
Grid-connected power factor setting	-1.000~1.000		-
Grid-connected reactive power ratio setting	-100.0~100.0		%
Grid-connected constant power value (DC)	-110.0~110.0		%
Grid-connected constant power value (AC)	-110.0~110.0		%
Grid-connected constant current value	-1077~1077	-1217~1217	A
Grid-connected constant voltage value	520.0~1000.0	580.0~1000.0	V
Grid-connected constant voltage current limiting value	0~1077	0~1217	A

Parameter name	Data range		Unit
	SC500TL	SC630TL	
Stand-alone converter voltage value	315.0~396.0	350.0~440.0	V
50Hz stand-alone converter frequency value	45.00~55.00		Hz
60Hz stand-alone converter frequency value	55.00~65.00		Hz
Output VSG rated voltage value	350.0~360.0	390.0~400.0	V
Output VSG rated frequency value (50Hz)	49.00~51.00		Hz
Output VSG rated frequency value (60Hz)	59.00~61.00		Hz
VSG frequency sagging slope	1.0~2.0		
VSG voltage sagging slope	1.0~2.0		
VSG active setting value	-100.0~100.0		%
VSG reactive setting value	-100.0~100.0		%
Grid-connected active power rise slope	0.5~2000.0		%/s
Grid-connected active power drop slope	0.5~2000.0		%/s
Grid-connected reactive power rise slope	0.5~2000.0		%/s
Grid-connected reactive power drop slope	0.5~2000.0		%/s
Battery charging voltage upper limit	520.0~1000.0	580.0~1000.0	V
Battery discharging voltage lower limit	520.0~1000.0	580.0~1000.0	V
Maximum battery charging current	-1077~0	-1217~0	A
Maximum battery discharging current	0~1077	0~1217	A
Frequency traversal enable	-		
Frequency traversal compensation factor	0.0~100.0		
Grid-connected over-frequency derating control switch			
50Hz grid-connected over-frequency derating initial point	50.20~55.00		Hz
60Hz grid-connected over-frequency derating start point	60.20~65.00		Hz
Grid-connected over-frequency derating slope	0.0~100.0		%/Hz
QU voltage rise start point	100.0~110.0		%
QU voltage rise end point	100.0~110.0		%
QU voltage drop start point	90.0~100.0		%
QU voltage drop end point	90.0~100.0		%
QU operation mode	-		
Maximum QU reactive power	0.0~100.0		%
Maximum QU PF	0.800~1.000		



Parameter name	Data range		Unit
	SC500TL	SC630TL	
QU enabling power	0.0~100.0		%
Shutdown delay time T	0~600		s
Shutdown slope L	1~100		%/s
Automatic recovery time	1~600		s
Battery energy management selection	-		
SOC upper limit for battery charging of the converter unit	1~100		%
SOC lower limit for battery discharging of the converter unit	1~100		%
BMS closing/opening/reset	-		

Description of Protection Parameters

Parameter	Description
LVRT voltage1(%)	Refer to Fig8-1LVRT requirements for large and medium sized plant
LVRT voltage2(%)	Refer to Fig8-1LVRT requirements for large and medium sized plant
LVRT voltage3(%)	Refer to Fig8-1LVRT requirements for large and medium sized plant
LVRT voltage4(%)	Refer to Fig8-1LVRT requirements for large and medium sized plant
LVRT voltage5(%)	Refer to Fig8-1LVRT requirements for large and medium sized plant
LVRT dynamic Var Kf factor	Ratio of reactive power compensation and voltage dropping depth during LVRT
LVRT switch	Enable or disable the LVRT switch
LVRT T1(ms)	Refer to Fig8-1LVRT requirements for large and medium sized plant, T1
LVRT T2(ms)	Refer to Fig8-1LVRT requirements for large and medium sized plant, T2
LVRT T3(ms)	Refer to Fig8-1LVRT requirements for large and medium sized plant T3
LVRT T4(ms)	Refer to Fig8-1LVRT requirements for large and medium sized plant, T4
LVRT T5(ms)	Refer to Fig8-1LVRT requirements for large and medium sized plant, T5
HVRT voltage1(%)	Refer to Fig8-2HVRT requirements for large and medium sized plant
HVRT voltage2(%)	Refer to Fig8-2HVRT requirements for large and medium sized plant

Parameter	Description
HVRT voltage3(%)	Refer to Fig8-2HVRT requirements for large and medium sized plant
HVRT voltage4(%)	Refer to Fig8-2HVRT requirements for large and medium sized plant
HVRT voltage5(%)	Refer to Fig8-2HVRT requirements for large and medium sized plant
Gird Recover Time(ms)	The grid under-/over-voltage and under-/over-frequency protection is enabled. The PCS will return to normal condition with operating conditions.
HVRT switch	Enable or disable the HVRT switch
HVRT T1(ms)	Refer to Fig8-2HVRT requirements for large and medium sized plant, T1
HVRT T2(ms)	Refer to Fig8-2HVRT requirements for large and medium sized plant, T2
HVRT T3(ms)	Refer to Fig8-2HVRT requirements for large and medium sized plant, T3
HVRT T4(ms)	Refer to Fig8-2HVRT requirements for large and medium sized plant, T4
HVRT T5(ms)	Refer to Fig8-2HVRT requirements for large and medium sized plant, T5
I_Vgrid-max(%)	Set the grid over-voltage protection I value. Protection is activated when voltage exceeds this value.
II_Vgrid-max(%)	Set the grid over-voltage protection II value. Protection is activated when voltage exceeds this value.
III_Vgrid-max(%)	Set the grid over-voltage protection III value. Protection is activated when voltage exceeds this value.
IV_Vgrid-max(%)	Set the grid over-voltage protection IV value. Protection is activated when voltage exceeds this value.
V_Vgrid-max(%)	Set the grid over-voltage protection V value. Protection is activated when voltage exceeds this value.
Recover_Vgrid-max(%)	The PCS will return to normal condition with operating conditions when grid voltage is below this value
I_T-Vhigh trip(ms)	Grid over-voltage protection I trip time
II_T-Vhigh trip(ms)	Grid over-voltage protection II trip time
III_T-Vhigh trip(ms)	Grid over-voltage protection III trip time
IV_T-Vhigh trip(ms)	Grid over-voltage protection IV trip time
V_T-Vhigh trip(ms)	Grid over-voltage protection V trip time

Parameter	Description
I_Vgrid-min(%)	Set the grid under-voltage protection I value. Protection is activated when voltage is below this value.
II_Vgrid-min(%)	Set the grid under-voltage protection II value. Protection is activated when voltage is below this value.
III_Vgrid-min(%)	Set the grid under-voltage protection III value. Protection is activated when voltage is below this value.
IV_Vgrid-min(%)	Set the grid under-voltage protection IV value. Protection is activated when voltage is below this value.
V_Vgrid-min(%)	Set the grid under-voltage protection V value. Protection is activated when voltage is below this value.
Recover_Vgrid-min(%)	The PCS will return to normal condition with operating conditions
I_T-Vlow trip(ms)	Grid under-voltage protection I trip time
II_T-Vlow trip(ms)	Grid under-voltage protection II trip time
III_T-Vlow trip(ms)	Grid under-voltage protection III trip time
IV_T-Vlow trip(ms)	Grid under-voltage protection IV trip time
V_T-Vlow trip(ms)	Grid under-voltage protection V trip time
50Hz I_Fgrid-max(Hz)	Set the 50Hz grid over-frequency protection I value. Protection is activated when frequency exceeds this value
50Hz II_Fgrid-max(Hz)	Set the 50Hz grid over-frequency protection II value. Protection is activated when frequency exceeds this value
50Hz III_Fgrid-max(Hz)	Set the 50Hz grid over-frequency protection III value. Protection is activated when frequency exceeds this value
50Hz IV_Fgrid-max(Hz)	Set the 50Hz grid over-frequency protection IV value. Protection is activated when frequency exceeds this value
50Hz V_Fgrid-max(Hz)	Set the 50Hz grid over-frequency protection V value. Protection is activated when frequency exceeds this value
50Hz Recover_Fgrid-max(Hz)	The PCS will return to normal condition with operating conditions when 50Hz grid frequency is below this value
60Hz I_Fgrid-max(Hz)	Set the 60Hz grid over-frequency protection I value. Protection is activated when frequency exceeds this value
60Hz II_Fgrid-max(Hz)	Set the 60Hz grid over-frequency protection II value. Protection is activated when frequency exceeds this value
60Hz III_Fgrid-max(Hz)	Set the 60Hz grid over-frequency protection III value. Protection is activated when frequency exceeds this value
60Hz IV_Fgrid-max(Hz)	Set the 60Hz grid over-frequency protection IV value. Protection is activated when frequency exceeds this value

Parameter	Description
60Hz V_Fgrid-max(Hz)	Set the 60Hz grid over-frequency protection V value. Protection is activated when frequency exceeds this value
60Hz Recover_Fgrid-max(Hz)	The PCS will return to normal condition with operating conditions when 60Hz grid frequency is below this value
I_T-Fhigh trip(ms)	Set the grid over-frequency I tripping time
II_T-Fhigh trip (ms)	Set the grid over-frequency II tripping time
III_T-Fhigh trip(ms)	Set the grid over-frequency III tripping time
IV_T-Fhigh trip (ms)	Set the grid over-frequency IV tripping time
V_T-Fhigh trip(ms)	Set the grid over-frequency V tripping time
50Hz I_Fgrid-min(Hz)	Set the 50Hz grid under-frequency protection I value. Protection is activated when frequency exceeds this value
50Hz II_Fgrid-min(Hz)	Set the 50Hz grid under-frequency protection II value. Protection is activated when frequency exceeds this value
50Hz III_Fgrid-min(Hz)	Set the 50Hz grid under-frequency protection III value. Protection is activated when frequency exceeds this value
50Hz IV_Fgrid-min(Hz)	Set the 50Hz grid under-frequency protection IV value. Protection is activated when frequency exceeds this value
50Hz V_Fgrid-min(Hz)	Set the 50Hz grid under-frequency protection V value. Protection is activated when frequency exceeds this value
50Hz recover_Fgrid-min(Hz)	The PCS will return to normal condition with operating conditions when 50Hz grid frequency is above this value
60Hz I_Fgrid-min(Hz)	Set the 60Hz grid under-frequency protection I value. Protection is activated when frequency exceeds this value
60Hz II_Fgrid-min(Hz)	Set the 60Hz grid under-frequency protection II value. Protection is activated when frequency exceeds this value
60Hz III_Fgrid-min(Hz)	Set the 60Hz grid under-frequency protection III value. Protection is activated when frequency exceeds this value
60Hz IV_Fgrid-min(Hz)	Set the 60Hz grid under-frequency protection IV value. Protection is activated when frequency exceeds this value
60Hz V_Fgrid-min(Hz)	Set the 60Hz grid under-frequency protection V value. Protection is activated when frequency exceeds this value
60Hz recover_Fgrid-min(Hz)	The PCS will return to normal condition with operating conditions when 60Hz grid frequency is above this value
I_T-Flow trip(ms)	Set the grid under-frequency I tripping time
II_T-Flow trip (ms)	Set the grid under-frequency II tripping time

Parameter	Description
III_T-Flow trip(ms)	Set the grid under-frequency III tripping time
IV_T-Flow trip (ms)	Set the grid under-frequency IV tripping time
V_T-Flow trip (ms)	Set the grid under-frequency V tripping time
Active Islanding	Enable or disable the islanding protection function
I leakage-pro(A)	Leakage current protection setting value
VGrid unbalanced pro-value(%)	3-phase grid voltage unbalance protection threshold value
VGrid unbalanced pro-time(s)	3-phase grid voltage unbalance time reaches to the set value. Protection is activated
Ins monitor measure time(s)	Insulation monitoring time
Ins monitor protect threshold(K)	Insulation monitoring protection threshold value
Fault manual start	Manual fault restart. If this function is enabled, the PCS can reconnect to the grid only after the fault is removed manually.
Ins monitor Vdc-start(V)	Insulation monitoring startup voltage. When the DC voltage reaches to this set value, the insulation monitoring enables.
Ins monitor manual	Insulation monitoring manual trigger button. Press this button and the insulation monitoring function enables.
DC undervoltage point	Set the DC undervoltage protection action voltage value
DC overvoltage point	Set the DC overvoltage protection action voltage value

#### Protection parameter setting range

Parameter	Data range		Unit
	SC500TL	SC630TL	
LVRT switch	Disable/Enable		
LVRT voltage1(%)	85~90		%
LVRT voltage2(%)	5~40		%
LVRT voltage3(%)	5~40		%
LVRT voltage4(%)	5~40		%
LVRT voltage5(%)	5~40		%
LVRT T1(ms)	2500~3500		ms
LVRT T2(ms)	500~1500		ms
LVRT T3(ms)	500~1500		ms
LVRT T4(ms)	500~1500		ms
LVRT T5(ms)	500~1500		ms
LVRT dynamic Var Kf factor	0~3		

HVRT switch	Disable/Enable	
HVRT voltage1(%)	110~120	%
HVRT voltage2(%)	120~140	%
HVRT voltage3(%)	120~140	%
HVRT voltage4(%)	120~140	%
HVRT voltage5(%)	120~140	%
HVRT T1(ms)	100~20000	ms
HVRT T2(ms)	100~5000	ms
HVRT T3(ms)	100~5000	ms
HVRT T4(ms)	100~5000	ms
HVRT T5(ms)	100~5000	ms
Gird Recover Time(ms)	1000~600000	ms
Grid overvoltage level 1 protection value	105.0~150.0	%
Grid overvoltage level 2 protection value	105.0~150.0	%
Grid overvoltage level 3 protection value	105.0~150.0	%
Grid overvoltage level 4 protection value	105.0~150.0	%
Grid overvoltage level 5 protection value	105.0~150.0	%
Grid overvoltage recovery value	105.0~150.0	%
Grid overvoltage level 1 tripping time	40~600000	ms
Grid overvoltage level 2 tripping time	40~600000	ms
Grid overvoltage level 3 tripping time	40~600000	ms
Grid overvoltage level 4 tripping time	40~600000	ms
Grid overvoltage level 5 tripping time	40~600000	ms
Grid undervoltage level 1 protection value	10.0~95.0	%
Grid undervoltage level 2 protection value	10.0~95.0	%
Grid undervoltage level 3 protection value	10.0~95.0	%
Grid undervoltage level 4 protection value	10.0~95.0	%
Grid undervoltage level 5 protection value	10.0~95.0	%

Grid undervoltage recovery value	10.0~95.0	%
Grid undervoltage level 1 tripping time	40~600000	ms
Grid undervoltage level 2 tripping time	40~600000	ms
Grid undervoltage level 3 tripping time	40~600000	ms
Grid undervoltage level 4 tripping time	40~600000	ms
Grid undervoltage level 5 tripping time	40~600000	ms
50Hz grid overfrequency level 1 protection value	50.20~55.00	Hz
50Hz grid overfrequency level 2 protection value	50.20~55.00	Hz
50Hz grid overfrequency level 3 protection value	50.20~55.00	Hz
50Hz grid overfrequency level 4 protection value	50.20~55.00	Hz
50Hz grid overfrequency level 5 protection value	50.20~55.00	Hz
50Hz grid overfrequency recovery value	50.20~55.00	Hz
60Hz grid overfrequency level 1 protection value	60.20~55.00	Hz
60Hz grid overfrequency level 2 protection value	60.20~55.00	Hz
60Hz grid overfrequency level 3 protection value	60.20~55.00	Hz
60Hz grid overfrequency level 4 protection value	60.20~55.00	Hz
60Hz grid overfrequency level 5 protection value	60.20~55.00	Hz
60Hz grid overfrequency recovery value	60.20~55.00	Hz
Grid overfrequency level 1 tripping time	40~600000	ms
Grid overfrequency level 2 tripping time	40~600000	ms
Grid overfrequency level 3 tripping time	40~600000	ms
Grid overfrequency level 4 tripping time	40~600000	ms

Grid overfrequency level 5 tripping time	40~600000	ms
50Hz grid underfrequency level 1 protection value	45.00~49.80	Hz
50Hz grid underfrequency level 2 protection value	45.00~49.80	Hz
50Hz grid underfrequency level 3 protection value	45.00~49.80	Hz
50Hz grid underfrequency level 4 protection value	45.00~49.80	Hz
50Hz grid underfrequency level 5 protection value	45.00~49.80	Hz
50Hz grid underfrequency recovery value	45.00~49.80	Hz
60Hz grid underfrequency level 1 protection value	55.00~59.80	Hz
60Hz grid underfrequency level 2 protection value	55.00~59.80	Hz
60Hz grid underfrequency level 3 protection value	55.00~59.80	Hz
60Hz grid underfrequency level 4 protection value	55.00~59.80	Hz
60Hz grid underfrequency level 5 protection value	55.00~59.80	Hz
60Hz grid underfrequency recovery value	55.00~59.80	Hz
Grid underfrequency level 1 tripping time	40~600000	ms
Grid underfrequency level 2 tripping time	40~600000	ms
Grid underfrequency level 3 tripping time	40~600000	ms
Grid underfrequency level 4 tripping time	40~600000	ms
Grid underfrequency level 5 tripping time	40~600000	ms
Leakage current protection value	1.00~10.00	A
Active island enabling	-	
Grid voltage unbalance protection value	3.0~20.0	%
Grid voltage unbalance protection time	0.1~600.0	s
Insulation monitoring protection	15~100	K



threshold

Insulation monitoring measurement time	-	-	s
Manual start after fault	-	-	-
Manual insulation monitoring	-	-	-
DC undervoltage point	510.0~1050.0	570.0~1050.0	V
DC overvoltage point	510.0~1050.0	570.0~1050.0	V

**⚠ WARNING**

**Improper parameter configuration may affect the normal operation of the PCS!**  
**Only authorized personnel can configure these parameters.**  
**Should any question or doubt occurs, please contact Sungrow.**

### 7.3 Information Viewing

After entering the WEB SERVER interface, click① "Device Monitoring" →② "Data Display" →③slide the scroll bar up and down to view the required information.

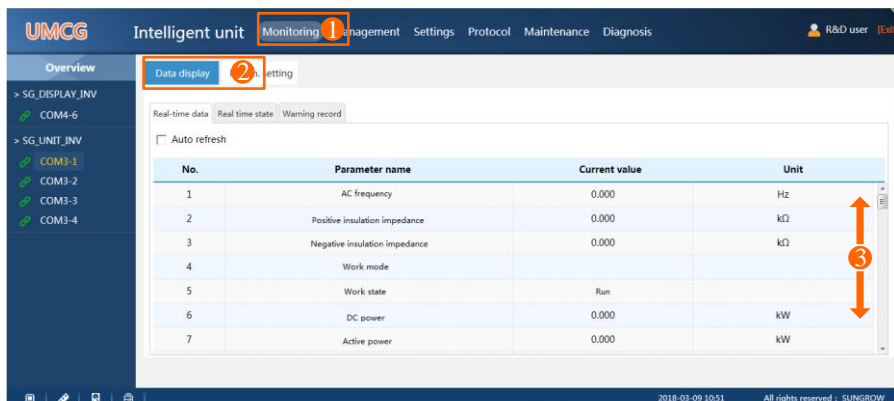

## 8 Converter Functions

### 8.1 LVRT

It is prescribed that the large and medium sized plant should be equipped with LVRT function.

LVRT requires: plant can operate normally within certain voltage drop range and duration when the voltage of the grid-connected point drops due to the power system failure or disturbance. Besides, the followings should also be met:

#### Active power recovery

If the power station still connects to the grid during power system failure, the active power will recover from the moment the fault is removed at the speed of at least 30% nominal power/second.

#### Dynamic reactive current support

During LVRT, power station should feed reactive current to the power system as per requirements. For a station whose 500kV or 750kV voltage is stepped up from the 220kV or 330kV voltage and then connects to the power station group, it should feed dynamic reactive current to the grid when a short-circuit fault occurs and the voltage drops.

#### Zero voltage ride through

When the grid-connection point voltage drops to zero, power station can operation normally for 0.15 second.

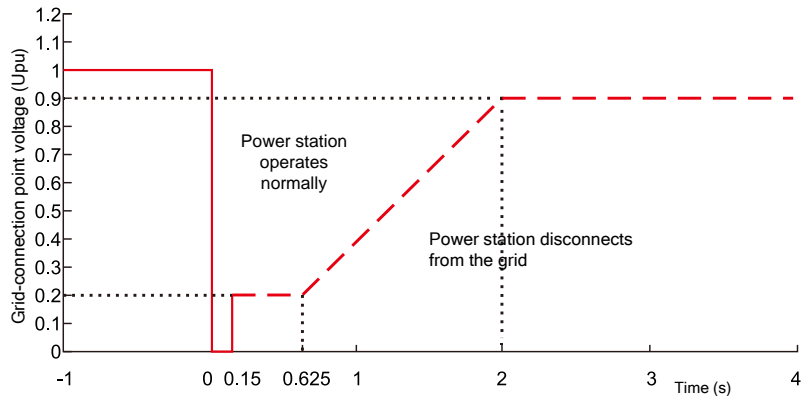

**Fig8-1** LVRT requirements for large and medium sized plant

The PCS meets the abovementioned requirements.

### 8.2 HVRT

According to <Technical regulations of power station access to grid>, the power station can operate in a certain range of grid-connection point voltage, detail requirements of HVRT are as follows:

Grid-connection point voltage range	Requirements of station
$1.1U_{pu} < U_T < 1.2U_{pu}$	Operate at last 10s
$1.2U_{pu} \leq U_T \leq 1.3U_{pu}$	Operate at last 0.5s

In this table ,  $U_T$  is the grid-connection point voltage ,  $U_{pu}$  is the rated grid-connection point voltage.

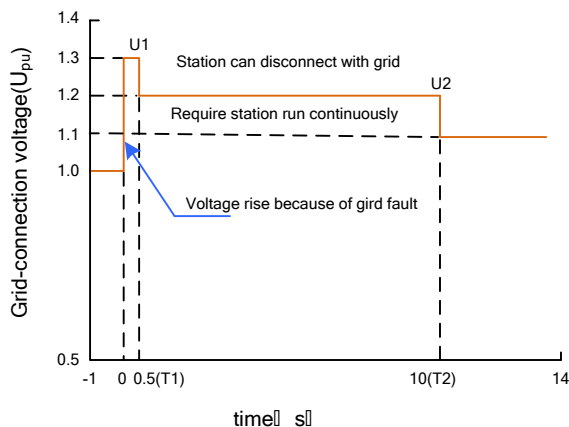

**Fig8-2** HVRT requirements for large and medium sized plant

The PCS meets the abovementioned requirements.

### 8.3 Protection Functions

PCS has perfect protection functions to protect the PCS when input voltage or grid is abnormal until the anomaly is removed and PCS can operate normally.

- DC over-/under-voltage protection

When the battery DC voltage exceeds the allowable range, PCS will stop operation, send warning signal and display the fault type on the WEB SERVER.

PCS can detect the anomaly and respond quickly.

- Grid over-/under-voltage protection

When the grid voltage exceeds the allowable range, PCS will stop operating, send warning signal and display the fault type on the WEB SERVER.

PCS can detect the anomaly and respond quickly.

- Grid over-/under-frequency protection

When the grid frequency exceeds the allowable range, PCS will stop operating, send warning signal and display the fault type on the WEB SERVER.

PCS can detect the anomaly and respond quickly.

- Islanding protection

When the grid voltage is detected to be 0 or the grid frequency exceeds the allowable range, PCS will stop operating, send warning signal and display the fault type on the WEB SERVER.

PCS can detect the anomaly and respond quickly.

### DANGER

**In anti-islanding protection state, high voltage is still present inside the PCS. Disconnect the main switch and discharge before testing or maintenance.**

- AC over-current protection

When the power of the energy storage battery exceeds the maximum DC power allowed by the PCS, the PCS will limit the current operation to the maximum allowable AC power. When the AC current is detected to be greater than 1.2 times the rated power, the PCS can continue to run for 10 minutes; it will stop working after overload operation. After returning to normal, the PCS should work normally.

- AC leakage current protection

The energy storage converter has a grounding protection function. The grounding cable is equipped with a leakage current sensor. When the leakage current exceeds the limit value, the system immediately issues a command to stop the machine and displays the fault type through the Web Server interface.

Parameter	SC500/630TL	
	Range	Default
Grounding Protective Action Value	1~10A	5A

- Module over-temperature protection

PCS IGBT module is equipped with high-precision thermal sensor to monitor the real-time temperature of the module. Once over-temperature is detected, DSP will help to maintain the safe operation of the PCS by sending instruction to stop the PCS.

- Ambient over-temperature protection

PCS is equipped with high-precision thermal sensor to monitor the PCS internal temperature. Once over-temperature is detected, DSP will help to maintain the safe operation of the PCS by sending instruction to stop the PCS or derate the power output.

- AC voltage unbalance

When the three-phase AC voltage differences detected exceed the allowable range, PCS will stop operating, send warning signal and display the fault type on the WEB SERVER interface.

PCS can detect the anomaly and respond quickly.

- Reactor over-temperature

The reactor is equipped with high-precision thermal sensor to monitor the temperature of the module. Once over-temperature is detected, DSP will help to maintain the safe operation of the PCS by sending instruction to stop the PCS.

- Module fault

PCS IGBT module is equipped with self-protection function. When over-current is detected during module self-detection, module will send fault information to the DSP. And the DSP will send instruction to stop the PCS and send warning signal and display the fault type on the WEB SERVER interface.

- Fan fault

PCS fans have self-detection function. When the fans stop running is detected, fan will send fault information to the DSP. And the DSP will send instruction to stop the PCS and send warning signal and display the fault type on the WEB SERVER interface.

- AC main contactor fault

When the PCS is in Stop or Fault and the AC main contactors are detected to be connected;  
When the PCS is in Standby, Grid mode, or Off-grid mode status and the AC main contactors are detected to be disconnected, PCS will stop operating, send warn signal and display the fault type on the WEB SERVER interface. When the anomaly is removed, PCS begins self-detection and then starts normal operation.

- Sampling channel fault

If PCS detects that the sampling channel zero-offset value exceeds the allowable range, PCS will send warning signal and display the fault type on the WEB SERVER interface.

- Reversed polarity connection fault

When it is detected that the DC voltage is a negative value and less than -100V, PCS will send warning signal and display the fault type on the WEB SERVER interface.

## 9 Routine Maintenance

Due to the effect of ambient temperature, humidity, dust and vibration, the inner components of the PCS will be aging and worn out. To ensure the system safety and maintain the efficiency of the PCS, it is necessary to carry out routine and periodic maintenance.

All methods or operations to keep the PCS in good working condition are PCS maintenance.

### 9.1 Safety Instructions

#### 9.1.1 Safety Rules

##### WARNING

**Only qualified personnel can perform the work described in this chapter.**

**Do not leave any screws, washers or other metallic parts inside the PCS to avoid damages to the PCS.**

##### WARNING

**Disconnection of the switches in no way implies that there is no voltage of the cable connection terminals inside the AC and DC cabinet. To avoid the risk of electric shock before opening the cabinet door,**

- **Disconnect the switches;**
- **Disconnect the upstream and downstream switch of the PCS.**

##### WARNING

**Wait at least 15 minutes after PCS stops before any work on the PCS.**

#### 9.1.2 Five Safety Rules

Respect the following five rules during maintenance or service on the PCS to ensure the safety of the maintainer.

- Disconnect the PCS from all the external connections and internal power supplies.
- Ensure that the PCS will not be started accidentally.
- Verify that the PCS interior is discharged completely with a multimeter.
- Necessary ground and short circuit connect.
- Cover the adjacent electrical components with insulation cloth during operation.

### 9.2 Maintenance and Interval

Recommended routine maintenance work and maintenance interval are shown in the following table.

Item	Method	Interval
Save software data	<ul style="list-style-type: none"> <li>• Read out LCD touch screen data;</li> <li>• Save running data, parameters and logs to a disk or a file;</li> <li>• Check each parameter setting;</li> <li>• Update software</li> </ul>	Once a month
System general running status and environment	<ul style="list-style-type: none"> <li>• Check the PCS for visible damages or deformation;</li> <li>• Check the PCS for any abnormal noise during running;</li> <li>• Check each parameter of the PCS during normal operation;</li> <li>• Check the principal components;</li> <li>• Check if the enclosure temperature is normal with the thermal imager;</li> <li>• Check the air inlet and outlet;</li> <li>• Check the ambient humidity, dust and air inlet filter;</li> </ul> <p><b>Notice!</b> Check the air inlet and outlet. The equipment may be damaged by overheating.</p>	Every six months
System cleaning	<ul style="list-style-type: none"> <li>• Check whether the circuit board and the component are clean;</li> <li>• Check the temperature and dust of the heat-sink. Use pressurized air and open the fan to clean the module if necessary;</li> <li>• Replace the air filter.</li> </ul>	From every six months to annually depending on the dust deposits.
Power circuit connection	<ul style="list-style-type: none"> <li>• Check whether the power cable connections are loose. Retighten them with the torque specified in the manual if necessary;</li> <li>• Check if the power cables and control cables, especially the surface in contact with the metal are damaged;</li> <li>• Check if the wrap belt of the connection terminals is strip-off.</li> </ul>	Six months after commissioning for the first time and then once every six month to a year
Terminal and cable connection	<ul style="list-style-type: none"> <li>• Check whether the screws of the control terminals are loose. Refasten them with screwdriver if necessary;</li> <li>• Check whether the terminals of the main circuit are in poor contact and whether the screws are hot;</li> <li>• Check if the connection busbar or screws are discoloring.</li> <li>• Visual check the device terminal connection and cable layout</li> </ul>	Once per year
Fan maintenance and replacement	<ul style="list-style-type: none"> <li>• Check if there is crack in the fan blade;</li> <li>• Check if there is abnormal noise during the running of the fan;</li> <li>• Replace the fan if necessary</li> </ul>	Once per year

Item	Method	Interval
Switches maintenance	<ul style="list-style-type: none"> <li>• Routine check of the corrosion of the metal components</li> <li>• Annually check the contactors (auxiliary switches and micro-switches) to ensure the optimal operation;</li> <li>• Check the running parameters (Voltage and insulation especially)</li> </ul>	From every six months to annually
Safety function	<ul style="list-style-type: none"> <li>• Check the emergency stop button and the LCD stop function;</li> <li>• Simulation shutdown and check the shutdown signal communication signal;</li> <li>• Check the warning labels and other markings for damage or unclarity. Replace them if necessary.</li> </ul>	From every six months to annually
Software maintenance	<ul style="list-style-type: none"> <li>• Optimize software</li> <li>• Check each parameter setting</li> </ul>	From every six months to annually

### WARNING

**Wait at least 15 minutes after the PCS discharge completely since the DC bus contains capacitance. Before cleaning, make sure, with multimeter, the PCS internal is discharged completely to avoid electric shock.**

### WARNING

**Almost all maintenance work needs to remove the internal protective grid during maintenance. Make sure to reassembly the grid and fasten all the screws after the maintenance work.**

**Make sure all bolts are securely fixed.**



The frequency of maintenance operations could be increased according to the environmental conditions of the place where the PCS is suited, plant capacity and on-site situations.

## 9.3 Filter Checking and Cleaning

1. Read the safety instructions carefully.
2. Open the cabinet door.
3. Check the air filter. If it needs to be replaced, remove it with a screwdriver. Please notice the direction of the filter cotton.
4. Check the cabinet cleanness. If necessary, clean the cabinet with soft rag or vacuum cleaner.
5. Close the cabinet door.



## 9.4 Replacing Electrical Components

### WARNING

**The electrical components inside the PCS must be replaced by the same components from the same manufacturer and with the same model number.**

**The model number can be acquired from the marking of the PCS or the component itself. If otherwise, please contact Sungrow.**

### WARNING

**If you needs to replace the components with products from other manufacturer and with different model number, a prior analysis and confirmation by Sungrow is needed.**

**Failure to follow this procedure may lead to physical injury or death and void all warranty from Sungrow.**

## 10 Troubleshooting

### WARNING

**Lethal voltages are present inside the PCS when a fault occurs.**

- **Only qualified personnel can perform the troubleshooting described in this chapter. Qualified means that the operator has received professional training on devices troubleshooting.**
- **Do not perform any troubleshooting other than that specified in this manual.**
- **Respect all safety instructions during troubleshooting.**

Should any questions or doubts arise that are not covered by this manual, please contact us.

If you provide our customer service assistant the following information, it will be of great help for us to diagnose and solve the problem in your system:

- Type of the PCS
- Serial number of the PCS
- Manufacturer, model and configuration of the battery and other modules connected to the PCS
- PCS communication solution
- Fault and brief description of the fault phenomenon
- A picture of the fault if necessary

### 10.1 Fault Checking

If any power output anomaly or charge/discharge anomaly is observed, you may check the following items before contacting Sungrow.

- Open-circuit voltage of the storage battery
- State of the emergency stop button
- Grid is connected correctly
- Measurement board communication is normal

### 10.2 Fault and Troubleshooting of LED

LED state	Description
No LED is on	Disconnect the AC/DC voltage for 5 minutes. Reconnect the AC/DC voltage. If the LEDs keep off, repair or replace them. Contact Sungrow if the malfunction cannot be removed following these instructions.

LED state	Description
POWER is off	No power supply to the PCS. First ensure the power supply and the grid-connection are normal. Disconnect the AC/DC voltage for 5 minutes and reconnect them. If the LED keeps off, please contact Sungrow.
OPERATION is off	PCS is not in Run status. First check all the AC/DC connection. Make sure, using multimeter, that the voltage exceeds the PCS startup voltage. Make sure the grid and parameters meet the requirements of PCS safe operation. If the malfunction cannot be removed by following these instructions, please contact Sungrow.
FAULT is on	A fault occurs and is not removed yet. Please refer to the touch screen for the detailed fault information and take corresponding troubleshooting. If the malfunction cannot be removed by following these instructions, please contact Sungrow.

### 10.3 Fault and Troubleshooting on the LCD screen

This section is dedicated to the faults shown on the LCD, possible reasons and troubleshooting. In case the fault cannot be removed following the instructions in this section, please contact Sungrow.

Fault	Possible reason	Measures	note
Vdc-high	DC voltage exceeds the maximum DC voltage	Check the configuration of the battery and reduce the battery open-circuit voltage	Contact the battery manufacturer
Vdc-low	DC voltage is lower than the minimum DC voltage	Check the configuration of the battery and increase the battery open-circuit voltage	Contact the battery manufacturer
Idc-high	PCS short-circuit or internal component damage	Check the PCS DC side cable connection and control circuit board for anomaly	Contact Sungrow
Vac-high	Grid voltage exceeds the maximum grid voltage	Check the grid (or if the grid-connection cables are too thin)	Recover operation when grid voltage is back to normal
Vac-low	Grid voltage is lower than the minimum grid voltage	Check the grid	Recover operation when grid voltage is back to normal
Fre-high	Grid frequency exceeds the maximum grid frequency	Check the grid Reconnect to the grid manually when grid frequency is back to normal	Recover operation when grid frequency is back to normal
Fre-low	Grid frequency is lower than the maximum grid frequency	Check the grid Reconnect to the grid manually when grid frequency is back to normal	Recover operation when grid frequency is back to normal

<b>Fault</b>	<b>Possible reason</b>	<b>Measures</b>	<b>note</b>
Iac-high	PCS short-circuit or internal component damage	Check the PCS AC side cable connection and control circuit board for anomaly	Contact Sungrow
Island	Islanding is detected	Check the grid	Reconnect to the grid when grid is back to normal.
Phase-flt	Grid voltage phase error	Check the grid	Recover operation when grid voltage is back to normal
PM-flt	Device internal fault	Device internal fault. First disconnect the AC and DC current, then disconnect the control circuit, and reconnect.  Contact Sungrow if this fault still occurs	Contact Sungrow if this fault occurs 5 times per day
PM tem high	Module temperature exceeds the allowable range	Check the module when the device is discharged completely	Contact Sungrow if this fault occurs 10 times per day
Temp-high	PCS internal temperature exceeds the allowable range	Check the cooling fan when the device is discharged completely	Contact Sungrow if this fault occurs 10 times per day
AD sample-flt	Circuit board sampling channel damaged	Check if the PCS sampling circuit board is abnormal	Recover operation when sampling channel is back to normal
DSP-com-flt	Communication fault between the DSP and PC	Check if the DSP board is loose	Contact Sungrow
Battery-flt	DC side abnormal	Check if the storage battery is correctly connected	Contact Sungrow
BMS-com-flt	Communication fault between the PCS and BMS	Check if the PCS is correctly connected to the BMS	Contact Sungrow
AC main contactor-flt	Contact connected to grid fault	Check the contactor when the device is discharged completely	Contact Sungrow if this fault occurs 5 times per day
DC main contactor-flt	Contact connected to the battery fault	Check the contactor when the device is discharged completely	Contact Sungrow if this fault occurs 5 times per day
Vac unbalanced	Voltage differences of the three phase exceed the allowable range	Check the grid	Recover operation when grid voltage is back to normal
Reversed polarity-flt	DC voltage positive and negative polarity connected reversely	Check the positive and negative polarity of the storage battery	Recover operation when DC voltage is back to normal

Fault	Possible reason	Measures	note
lac leak-pro	PCS AC leakage current exceeds the allowable range	-	Recover operation when leakage current is back to normal
Fan-flt	Fan internal short-circuit	Check the fan when the device is discharged completely	Contact Sungrow if this fault occurs 10 times per day

## 10.4 Other Faults

### Heat-Sink is Over-Temperature

Possible reason: cooling fan failure; over-temperature of the air inlet and outlet; bad ventilation of the switch room, etc.

Solution: check and replace the cooling fan; reduce the temperature of the switch room; clean the air duct and widen the air duct.

### Noise is Too Loud during PCS Operation

Possible reason: abnormal operation of the PCS and transformer; fan failure.

Solution: check if the power is within the allowable range; measure if the grid-connected current and voltage waveform are normal (if not, the noise will be loud and the electric reactor will be overheating); check and replace the fan.

### LCD Touch Screen Cannot Start or Stop PCS

Possible reason: communication malfunction between the LCD touch screen and the DSP; LCD power supply malfunction.

Solution: check the connection between the LCD touch screen and the DSP.

### Communication Failure with PC

For serial port communication:

1. Check to ensure the circuits are properly connected and A/B is connected correctly.
2. Check if the communication adapter is matched. Communicate again after replacing the adapter.
3. Check if the local address is the same with the PC.

For Internet communication

1. Check if the IP address, subnet mask and gateway are set correctly.
2. Check if the communication cables are through line and connected properly.
3. If all above-mentioned items are correct and this fault still occurs, replace the LCD measurement board.

#### NOTICE

**The monitor disk might be incompatible with the antivirus software and thus cannot be installed correctly. You are recommended to disable the antivirus software and then install the monitor software.**

# 11 Appendix

## 11.1 Technical Data

Parameter	SC500TL	SC630TL
<b>DC side parameter</b>		
Max. DC input voltage		1000V
Min. DC input voltage	520V	580V
DC voltage range (at nominal power)	520 ~ 850 V	580 ~ 850 V
Max. DC input current	1077A	1217A
Max. DC input power	560kW	706kW
<b>AC side parameter(Grid side)</b>		
Output Power	550 kVA @ 50 °C / 500 kVA @ 55 °C	693 kVA @ 50 °C / 630 kVA @ 55 °C
Max. AC output current	882A	1000A
Nominal grid voltage	360V	400V
Grid voltage range	315 ~ 396 V	350 ~ 440 V
Nominal grid frequency / Grid frequency range	50 Hz / 45 ~ 55 Hz, 60 Hz / 55 ~ 65 Hz	
Max. THD	< 3 % (at nominal power)	
DC current injection	< 0.5 % I <sub>n</sub>	
Power factor at nominal power / Grid-connected power factor range	> 0.99 / 1 leading ~ 1 lagging	
Adjustable reactive power	-100% ~ 100%	
<b>AC side parameter(Off-gird)</b>		
Nominal AC voltage	360V	400V
AC voltage range	315 ~ 396V	350 ~ 440V
Max. THD	< 3 % (linear load)	
DC current injection	< 0.5 % Un (linear load)	
Load imbalance	100 %	
Voltage dynamic range	≤10% (resistance load jumps from 0 to 100%)	

Parameter	SC500TL	SC630TL
<b>AC side (VSG)</b>		
Nominal AC voltage	360V	400V
Voltage command range	350 ~ 360V	390 ~ 400V
Voltage command range...	49 – 51 Hz / 59 – 61 Hz	
Active power command range	-500 ~ 500 kW	-630 ~ 630 kW
Reactive power command range	-500 ~ 500 kVar	-630 ~ 630 kVar
<b>Efficiency</b>		
Max. efficiency / European efficiency	99 % / 98.7 %	
<b>Protection</b>		
DC input protection	Load switch + fuse	
AC output protection	Breaker	
Overvoltage protection	DC Type II / AC Type II	
Grid monitoring / ground fault monitoring	Yes / Yes	
Insulation monitoring	Yes	
Over temperature monitoring	Yes	
<b>General Data</b>		
Dimensions (W×H×D)	1005*1915*835 mm	
Weight	800kg	
Isolation	Transformerless	
Ingress protection rating	IP21	
External power supply	380 Vac, 1.7 kVA	
Operating ambient temperature range	-30 to 65 °C (> 55 °C Derating)	
Relative humidity	0 - 95% (Non-condensing)	
Cooling concept	Temperature-controlled forced air cooling	
Max. working altitude	5000m ( > 4000m Derating )	
Display	Touch screen	
Communication	Standard: RS485, CAN, Ethernet; Optional: Fiber	
Certificates	CE, IEC 62477, IEC 61000, SGSF	
Grid support	L/HVRT, L/HFRT, active & reactive control, power slope control	

Parameter	SC500TL	SC630TL
Type designation	SC500TL-V31	SC630TL-V11

## 11.2 Quality Assurance

When product faults occur during the warranty period, Sungrow will provide free service or replace the product with a new one.

### Evidence

During the warranty period, the customer shall provide the product purchase invoice and date. In addition, the trademark on the product shall be undamaged and legible. Otherwise, the Sungrow has the right to refuse to honor the quality guarantee.

### Conditions

- After replacement, unqualified products shall be processed by Sungrow.
- The customer shall give Sungrow a reasonable period to repair the faulty device.

### Exclusion of liability

In the following circumstances, Sungrow has the right to refuse to honor the quality guarantee:

- If the free warranty periods for the whole machine/components have expired.
- If the device is damaged during transport.
- If the device was incorrectly installed, refitted, or used.
- If the device is operated in a very improper environment, as described in this manual.
- If the fault or damage was caused by installation, repairs, modification, or disassembly performed by a service provider or personnel other than this company.
- If the fault or damage was caused by the use of non-standard or non-Sungrow components or software.
- If the installation and use range are beyond stipulations of relevant international standards.
- If the damage was caused by an abnormal natural environment.

For faulty products in any of above cases, if the customer requests maintenance, paid maintenance service may be provided based on the judgment of Sungrow's Service Department.

### Software licenses

- It is prohibited to use data contained in firmware or software developed by this company, in part or in full, for commercial purposes by any means.
- It is prohibited to reverse engineer, crack, or perform any other operations that compromise the original program design of the software developed by this company.



## 11.3 Contact Information

Should you have any question about this product, please contact us.

We need the following information to provide you the best assistance:

- Type of the converter
- Serial number of the converter
- Fault code/name
- Brief description of the problem

### China

SUNGROW POWER SUPPLY Co., Ltd  
Hefei  
+86 551 65327834  
service@sungrowpower.com

### Australia

SUNGROW Australia Group Pty. Ltd.  
NSW  
+61 2 9922 1522  
service@sungrowpower.com.au

### Brazil

SUNGROW Power do Brasil  
Sao Paulo  
+55 015 9 98197824  
kaue.oliveira@sa.sungrowpower.com

### France

SUNGROW France – Siege Social  
Paris  
+33 762899888  
service.france@sungrow.co

### Germany

SUNGROW Deutschland GmbH  
München  
+49 (0) 89 324914761  
service.germany@sungrow.co

### Greece

Service Partner – Survey Digital  
+30 2106044212  
service.greece@sungrow.co

### India

Sungrow India Pvt Ltd.  
Gurgaon  
+91 080 41201350  
service@in.sungrowpower.com

### Italy

SUNGROW Italy  
Milano  
+39 3391096413  
service.italy@sungrow.co

### Japan

SUNGROW Japan K.K.  
Tokyo  
+81 3 6262 9918  
japanservice@jp.sungrowpower.com

### Korea

SUNROW POWER KOREA LIMITED  
Seoul  
+82 70 7719 1889  
service@kr.sungrowpower.com

**Malaysia**

SUNGROW SEA  
 Selangor Darul Ehsan  
 +60 19 897 3360  
 service@my.sungrowpower.com

**Philippines**

SUNGROW POWER SUPPLY Co., Ltd  
 Mandaluyong City  
 +63 9173022769  
 service@ph.sungrowpower.com

**Thailand**

SUNGROW Power (Hong Kong) Co., Ltd.  
 Bangkok  
 +66 891246053  
 service@th.sungrowpower.com

**Spain**

SUNGROW Ibérica S.L.U.  
 Navarra  
 service.spain@sungrow.co

**Romania**

Service Partner - Elerex  
 +40 241762250  
 service.romania@sungrow.co

**Turkey**

SUNGROW Deutschland GmbH Turkey  
 Istanbul Representative Bureau  
 Istanbul  
 +90 212 731 8883  
 service.turkey@sungrow.co

**UK**

SUNGROW Power UK Ltd.  
 Milton Keynes  
 +44 (0) 0908 414127  
 service.uk@sungrow.co

**U.S.A, Mexico**

SUNGROW USA  
 Phoenix  
 +1 833 747 6937  
 techsupport@sungrow-na.com