

General Installation Manual

EVPVXXX SERIES (WHITE BACKSHEET)
EVPVXXXK SERIES (BLACK BACKSHEET)
EVPVXXXH SERIES (WHITE BACKSHEET)
EVPVXXXPK SERIES (BLACK BACKSHEET)
EVPVXXXHK SERIES (BLACK BACKSHEET)

Thank you for choosing EverVolt™ photovoltaic module. Please read this manual completely before you install or use of EverVolt™ module. With proper operation and maintenance, EverVolt™ module will provide you with clean, renewable solar electricity for many years. This manual contains important installation, maintenance and safety information. The word “module” as used in this manual refers to one or more PV modules. Retain this manual for future reference.

Table of Contents

Safety Precautions	2
• Warnings	
• Cautions	
Module Specifications	3
• Standards	
• Fire Class of Product	
• Junction Box, Terminals, and Connectors	
• Bypass Diode	
Installation	8
• General	
• Operating Conditions	
• Unpacking and Handling	
• Cable Management	
• Module Installation	
• Use of Rails and Clamps	
• Mounting with Continuous Rails Parallel to Long Side of the Module	
• Mounting with Short Rails	
• Mounting Methods: Mounting Holes	
Wiring	20
• General	
• Module Wiring	
• Array Wiring	
• Drainage Holes	
Maintenance	22
Disclaimer of Liability	22
Contact Information	22
Revision History	23
Annex 1: Installations Using Module Level Power Electronics	24

“EverVolt™” is a trademark of the Panasonic Group. Other product and service names listed in this manual are trademarks or registered trademarks of respective companies.

Safety Precautions

- All instructions should be read and understood before attempting to install, wire, operate, and maintain the module.
- The installation of modules requires a great degree of skill and should only be performed by qualified licensed professionals, including, without limitation, licensed contractors and licensed electricians.
- The installer assumes the risk of all injury that might occur during installation, including, without limitation, the risk of electric shock.
- Before installing modules, contact the appropriate authorities to determine permissions, installation and inspection requirements, which should be followed.
- Be sure that the construction or structure (roof, etc.) where the modules are being installed has enough strength.
- Both roof construction and module installation design have an effect on the fire resistance of a building. Improper installation may contribute to fire hazards. Additional devices such as ground fault, fuses, and disconnects may be required.
- For a non-integral module or module, the assembly is to be mounted over a fire resistant roof covering rated for the application.
- For modules mounted on roofs, special construction or structures may be required to help provide proper installation support.
- Do not install the module where flammable gases or vapors are present.
- Do not use modules of different specifications in the same system.
- Follow all safety precautions of other system components used.
- In some areas, local electrical codes may govern the installation and use of modules.

WARNING

To avoid the hazard of electric shock, sparks, fire and injury

- The modules generate DC electrical energy when exposed to sunlight or other light sources, so cover the entire front surface of the modules with a dense, opaque material such as a cardboard box, during installation and handling of the modules.
- The shock hazard increases as modules are connected in parallel, producing higher current, and as modules are connected in series, producing higher voltages.
- The shock hazard increases as modules rated for maximum system voltage in excess of 50 V.
- Wear suitable clothing, gloves and guards to prevent from direct contact with 30 VDC or greater.
- Work only in dry conditions, with dry modules and dry tools.
- Children and unauthorized persons should not be allowed near the installation of modules.
- Do not puncture or damage the backsheet of a module. Do not use the PV module and make a replacement, when scratch exposing conductive part is found on the backsheet.
- Do not disassemble the module, or remove any parts installed by the manufacturer.
- Do not open a junction box's lid.
- Do not touch the junction box terminals.
- Do not change the wiring of bypass diodes.
- Do not connect or disconnect terminals while modules generate electricity and connect electrical load.
- Never leave a module unsupported or unsecured.

CAUTIONS

To avoid the hazard of injury, burn and damage to the module

- Use a module for its intended purpose only.
- Be sure that all other system components are compatible, and they do not subject the module to mechanical or electrical hazards.
- Do not artificially concentrate sunlight on a module.
- Do not stand or step on a module.
- When carrying a module, two or more people should carry it by its frame and wear non-slip gloves.
- Do not carry a module by its wires or junction box.
- Do not drop a module.
- Do not drop anything on the surface of a module.
- Do not hit the back side of a module by the connector or other object. Back side is easily damaged.
- Do not stack anything on back side of module.
- Do not disassemble a module, attempt any repair, open the junction box cover, nor remove any parts installed by Panasonic. There are no user serviceable parts within the module or junction box.
- Do not treat the back sheet or front surface with paint or adhesives.
- Do not use or install broken modules. If you find a breakdown such as glass breakage, contact the professional installer to replace it promptly.
- Do not touch a module unnecessarily. The glass surface and frames get hot.

Module Specifications

- Module specifications are shown in Table 1, 2 and Figure 1, 2, 3. (Electrical specifications, mechanical specifications, module dimensions)
- Under real conditions, a photovoltaic module may experience conditions that produce more current and/or voltage than reported at Standard Test Conditions. Therefore, the I_{sc} value of modules should be multiplied by a factor of 1.25 to determine ampacity. An additional factor of 1.25 may be required for sizing conductors, fuses, disconnects, etc. Please refer to [section 690.8 of the National Electric Code \(NEC\)](#) for guidelines. The V_{oc} must be factored according to the lowest recorded ambient temperature recorded for the location where the modules will be installed. Please refer to [section 690.7 of the NEC](#) for more information regarding voltage temperature factors.

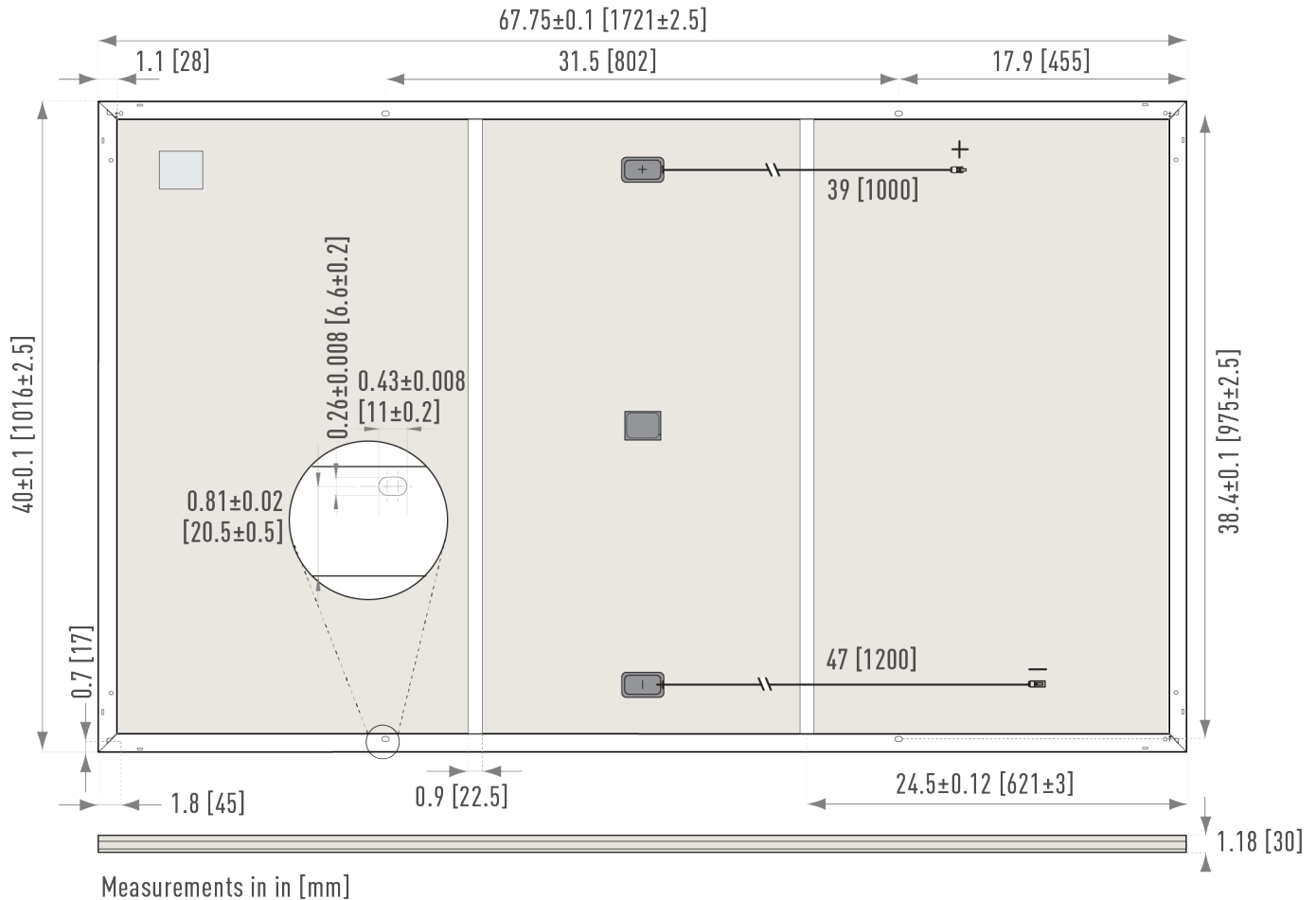

Figure 1. Module Dimension for EVPVxxx and EVPVxxxK Series and EVPVxxxHK Series

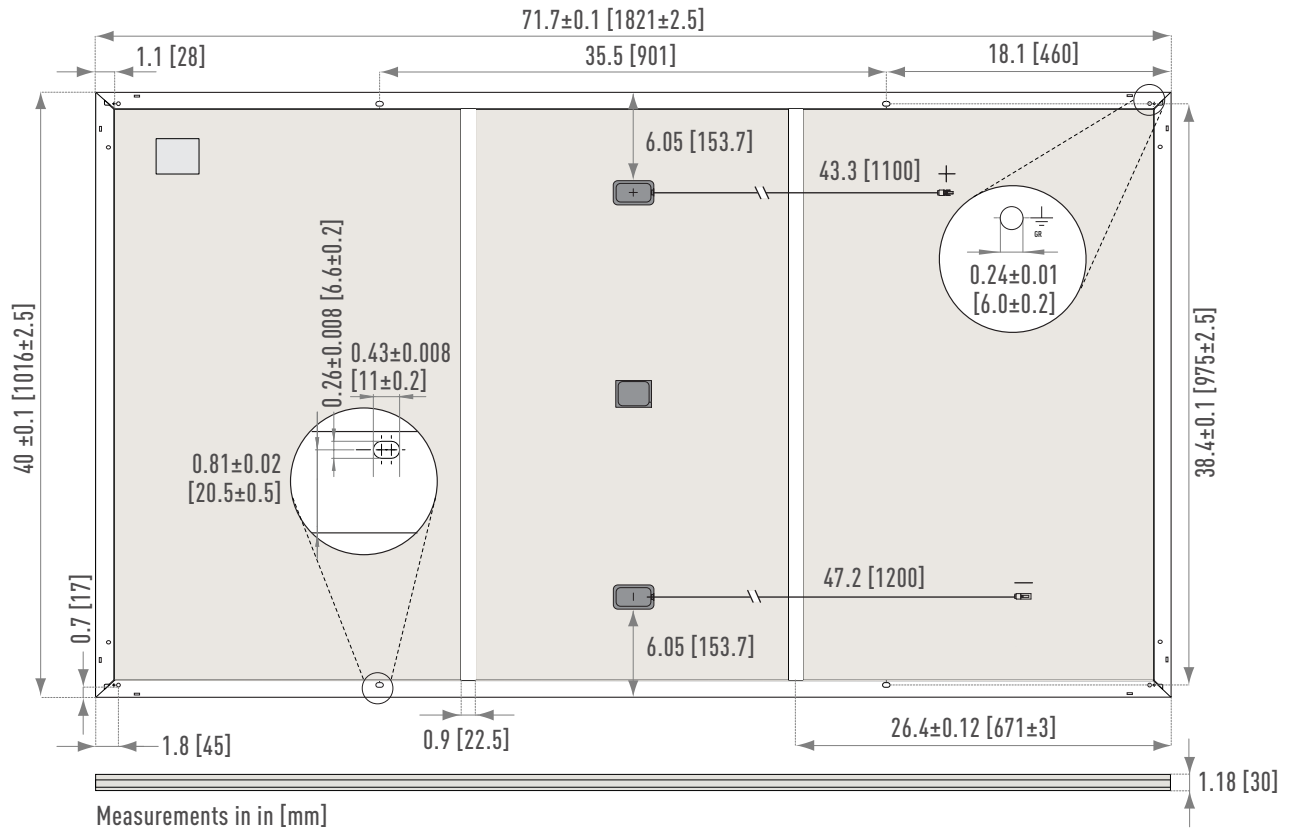

Figure 2. Module Dimension for EVPVxxxH and EVPVxxxHK Series

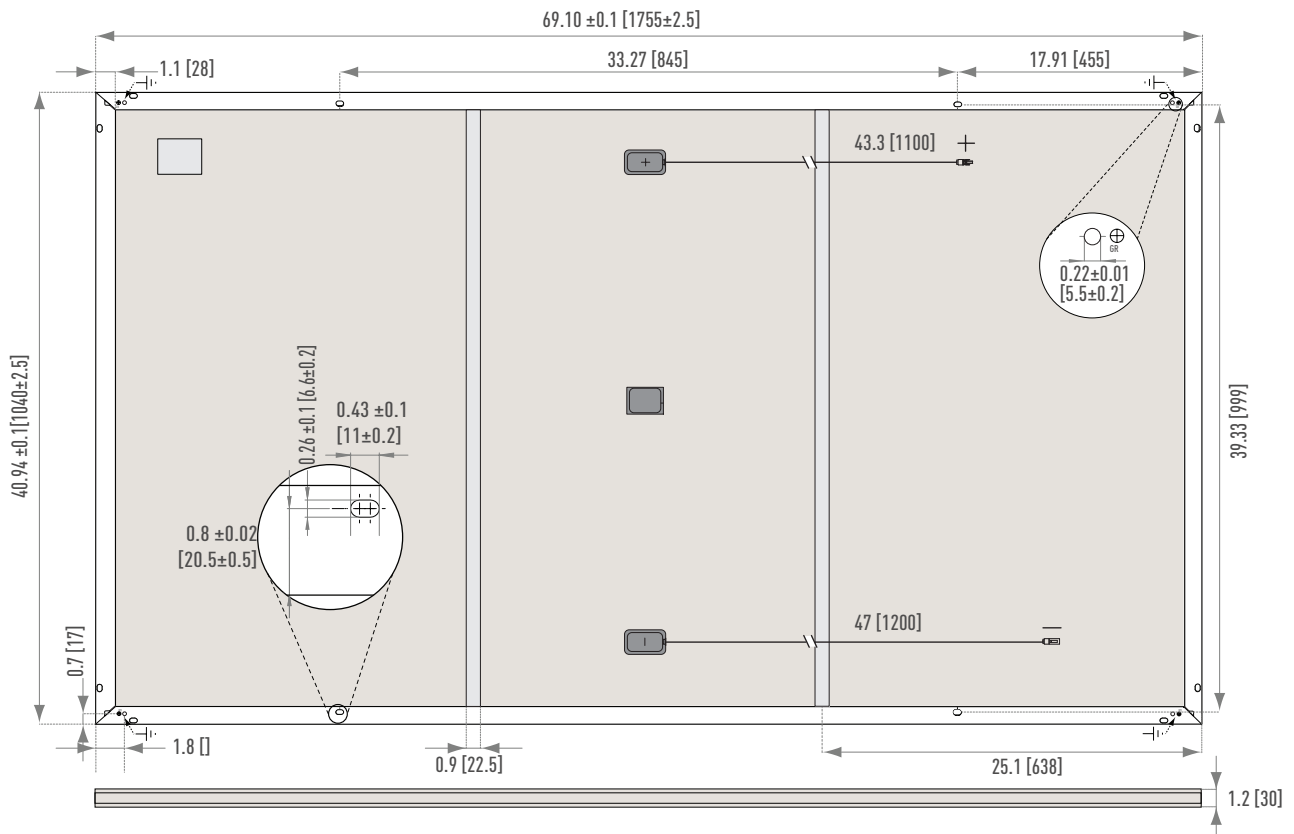

Figure 3. Module Dimension for EVPVxxxPK Series

Table 1. EVPVxxxH, EVPVXXX, EVPVXXXK SERIES

Electrical Specifications

Model	EVPV410H	EVPV400H	EVPV390H	EVPV380	EVPV370	EVPV360	EVPV370K	EVPV360K
Back sheet color	White	White	White	White	White	White	Black	Black
Rated Power, Watts (P_{max})	410W	400W	390W	380W	370W	360W	370W	360W
Watt Class Sorting	-0/+10W	-0/+10W	-0/+10W	-0/+10W	-0/+10W	-0/+10W	-0/+10W	-0/+10W
Maximum Power Voltage (V_{pm})	42.7V	42.1V	41.5V	38.1V	37.4V	36.7V	37.4V	36.7V
Maximum Power Current (I_{pm})	9.61A	9.51A	9.40A	9.98A	9.90A	9.82A	9.90A	9.82A
Open Circuit Voltage (V_{oc})	49.0V	48.8V	48.6V	44.3V	44.1V	43.9V	44.1V	43.9V
Short Circuit Current (I_{sc})	10.35A	10.25A	10.19A	10.61A	10.55A	10.49A	10.55A	10.49A
Cell Type	Silicon hetero-junction*							
Maximum System Voltage	1000V	1000V	1000V	1000V	1000V	1000V	1000V	1000V
Factory Installed Bypass Diodes	3	3	3	3	3	3	3	3
Maximum series fuse (A)	25	25	25	25	25	25	25	25
Length inches (mm)	71.7 (1821)			67.75 (1721)				
Width inches (mm)	40.0 (1016)							
Frame Depth Inches (mm)	1.2 (30)							
Weight pounds (kg)	45.0 (20.5)			43.0 (19.5)				

*Mono-crystalline silicon/ amorphous silicon hetero-junction

Values at standard test conditions (STC: air mass AM 1.5, irradiance 10.75 W/sq ft (1000 W/m²), temperature 77°F (25°C), based on a production spread with a tolerance of P_{MAX}, V_{OC} & I_{SC} ±3% within one watt class.

Table 2. EVPVXXXPK, EVPVXXXHK SERIES

Electrical Specifications

Model	EVPV370PK	EVPV360PK	EVPV350PK	EVPV410HK	EVPV400HK	EVPV390HK
Back sheet color	Black	Black	Black	Black	Black	Black
Rated Power, Watts (P_{max})	370W	360W	350W	410W	400W	390W
Watt Class Sorting	-0/+10W	-0/+10W	-0/+10W	-0/+10W	-0/+10W	-0/+10W
Maximum Power Voltage (V_{pm})	34.7V	33.9V	33.1V	42.7V	42.1V	41.5V
Maximum Power Current (I_{pm})	10.68A	10.62A	10.58A	9.61A	9.51A	9.40A
Open Circuit Voltage (V_{oc})	41.0V	40.6V	40.3V	49.0V	48.8V	48.6V
Short Circuit Current (I_{sc})	11.38A	11.26A	11.13A	10.35A	10.28A	10.22A
Cell Type	PERC			Silicon hetero-junction		
Maximum System Voltage	1000V	1000V	1000V	1000V	1000V	1000V
Factory Installed Bypass Diodes	3	3	3	3	3	3
Maximum series fuse (A)	25	25	25	25	25	25
Length inches (mm)	69.1 (1755)			71.7 (1821)		
Width inches (mm)	40.94 (1040)			40.0 (1016)		
Frame Depth Inches (mm)	1.2 (30)			1.2 (30)		
Weight pounds (kg)	44.0 (20.0)			45.0 (20.5)		

Values at standard test conditions (STC: air mass AM 1.5, irradiance 10.75 W/sq ft (1000 W/m²), temperature 77°F (25°C), based on a production spread with a tolerance of P_{MAX}, V_{OC} & I_{SC} ±3% within one watt class.

STANDARDS

EVPVxxx, EVPVxxxK, EVPVxxxH, EVPVxxxHK and EVPVxxxPK series are rated for use in Electrical Application Class A, Protection Safety Class II; at hazardous level of voltage (>35V), current (>8A) and power (>240W) where general contact access is anticipated (panels, qualified for safety through UL 61730-1 and -2).

FIRE CLASS OF PRODUCT

The EverVolt modules covered by this manual have a Class C (referencing UL790) and Type 2 fire classification according to UL1703/UL61730.

The fire performance rating of the modules is only valid when mounted in the manner specified in this installation manual.

The complete system fire class rating is to be achieved by the combination of module fire performance type and UL2703 certified mounting structure for a non-BIPV module.

Please refer to mounting structure UL2703 listing for System Fire Classification. Any specific limitations on the inclination or accessories required to maintain a specific System Fire Class Rating must be clearly specified in the mounting system manufacturer's installation instructions and UL2703 certification.

Utilize the following fire safety guidelines when installing EverVolt modules:

- Check with all relevant local authorities for fire safety requirements for any building or structure on to which the modules will be installed.
- The system design must ensure that

it can be easily accessed in the event of a building fire.

- Check with relevant authorities for applicable regulations concerning setbacks or other placement restrictions that may apply for roofmounted arrays.
- The use of DC ground fault interrupters is recommended. This may also be required by local and national codes.
- All electrical appliances are a fire risk. The module must be mounted over a fire retardant roof covering rated for the application and a distance of at least 0.8 in (20 mm) between the module and the mounting surface, to allow the free circulation of air beneath the modules at all times.

JUNCTION BOX, TERMINALS, AND CONNECTORS

- Modules equipped with three junction box contain terminals for both positive and negative polarity individually, and bypass diodes.
- Each terminal is dedicated to one polarity (with the polarity symbols engraved onto the body of the junction box) (see Figure 1).
- Each terminal is provided with factory installed lead cables and a latching connector for series and string connections. Always use these connectors and do not detach them from cables.
- The PV module comes pre-wired. Each module has two #12 AWG type PV-wire stranded sunlight resistant output cables each terminated with connectors. The positive (+) terminal has a male connector while the negative (-) terminal has a female connector. The module wiring is solely for series connections

- only, i.e. male (+) to female (-) interconnections. When making field wiring connections to the pre-attached connectors use only approved connectors from Table 2.
- All connectors and cables must be secure and tight as well as electrically and mechanically sound. UVresistant cables and connectors approved for outdoor use must be used. Conductor gauge must be chosen to ensure DC power losses (voltage drop) are kept to a minimum (<1%).
- Observe all local regulations when selecting cables.
- For string connections, use minimum 12 AWG (4 mm²) or copper wires insulated for a maximum operating temperature of 194°F (90°C).
- Avoid exposing cables to direct sunlight and permanent tension.
- To ensure connector compatibility and reduce the potential for damage to the modules and the wider installation, the connectors used on the EverVolt modules are detailed in the Figure 2. Only permitted the mating of factory-installed connectors to connectors of the same manufacturer, type, and system rating as shown in the table below (Table.2).
- Latching connectors are type IV and made by **STAUBLI ELECTRICAL CONNECTORS AG**. Supplied connectors listed by UL.
- In order to comply with NEC 2008, a locking sleeve needs to be used with all connectors that are exposed.
- The locking sleeve (PV-SSH4) is made by STAUBLI and can only be released with a special tool also made by STAUBLI (PV-MS). Locking sleeves are not supplied with modules and must be purchased separately.

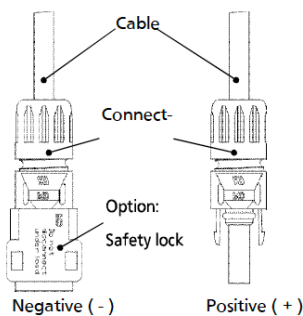

Figure 4. Connectors

CONNECTORS

Stäubli MC4 PV-KBT4/KST4, 12AWG(4 mm²) in accordance with IEC 62852 only when connected

Table 3. Approved connectors

Connector 1 + Connector 2		Permitted?
EverVolt Module Factory-Installed	EverVolt Module Factory-Installed	✓
EverVolt Module Factory-Installed	Stäubli MC4	✓
EverVolt Module Factory-Installed	Any other connector	NG

BYPASS DIODE

- When the modules in series strings are shaded partially, it may cause reverse voltage across cells or modules, because the current from other cells in the same series is forced to flow through the shaded area. This may cause undesirable heating to occur.
- The use of a diode to bypass the shaded area can minimize both heating and array current reduction.
- All modules are equipped with factory installed bypass diodes. The factory installed diodes provide

proper circuit protection for the systems within the specified system voltage, so that you do not need any other additional bypass diodes.

Installation

GENERAL

Please read this guide completely before installation or use of the modules.

OPERATING CONDITIONS

Panasonic recommends that modules be operated within the following Operating Conditions. An installation location with conditions beyond the Operating Conditions or with other Special Conditions (see below) should be avoided. Operating Conditions of Panasonic modules are as follows:

- 1) The modules should be operated only in terrestrial applications. No space or other Special Conditions.
- 2) The operating temperature must be within **-40°F(-40°C) to 185°F(85°C)**.
- 3) The wind pressure load of the installation site should be less than Load Resistance shown in "Mount Locations and Load Resistance" table in Figure 9-17.

So it is recommended to hold cardboard or frames when carrying or installing the solar module. When cables and connectors touch the surface of the glass, it may soil the surface too. It is also recommended to avoid contact of cables and connectors with surface of the glass.

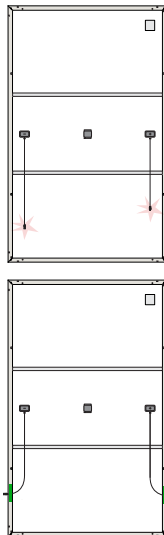

Figure 5. Fixing of cables and connectors

UNPACKING AND HANDLING

- Do not hit the back sheet of a module by the connector when unpacking and handling.
- Please do not expose the connector the rain water and dust.
- To avoid the damage of the back sheet by the connector, fix the cables to the frame with tape after unpacking. (refer Figure 5)
- Do not handle modules by their cables or junction box. Handle them by the frame with both hands in any situation.
- The anti-reflection glass of a module is easy to be soiled, when it is grasped by hand or hand gloves.

CABLE MANAGEMENT

To ensure a long life span of the cables and reduce the potential for damage to the cables, follow the instructions below:

- To prevent stress on the junction box casing, ensure the cable exits the junction box in a straight line before any bend in the cable.
- The cables must have a minimum bending radius of 1.2 in (30 mm) to avoid damage to the insulation (refer Figure 6).
- Ensure cables do not hang loose where they may be damaged through friction or stress, e.g.,

- caused by mechanical abrasion or grazing animals.
- Protect connectors from falling or dropping water by locating them directly beneath a module.
- Cables must be firmly secured to the structure, without over-tightening, as this can deform the cable insulation using UV-resistant cables.
- When securing the connector, place it so that it has with sufficient air circulation all around. This allows the connector to dry effectively and avoids the risk of damage or degradation of the connection.
- Secure the cable either side of the connectors to ensure no stress is exerted on the connector casing or cable entry.
- To enable correct cooling and drying of the connectors, do not add extra protection to the connector e.g., heat shrink, grease or tape.

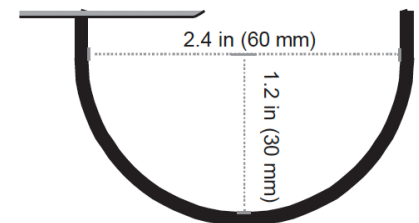

Figure 6. Minimum cable bend radius

MODULE INSTALLATION

EverVolt modules are designed for capturing solar radiation and can be installed where they conform to all local structural regulations. If installing EverVolt modules in overhead or vertical constructions, the installer must ensure that all local building codes and regulations specific to such installations are correctly followed. The IP rating of the junction box provides a level of protection that allows modules to be mounted in any orientation. There are different options for securing EverVolt modules depending on the design of the array. Mounting hardware is not supplied by Panasonic. Ensure the mounting structure can withstand anticipated wind and snow loads. Follow the mounting hardware manufacturer's instructions and recommendations at all times.

- Install modules where they are not shaded by obstacles like buildings or trees. Especially pay attention to avoid partially shading the modules by objects during the daytime. If a part of the PV module is always shaded, hot spot may occur and the PV module may break down.
- Water stains might be caused when rain water remains on the glass surface for a long time. To avoid water stains, Panasonic recommends to install modules at a slope steeper than the water gradient.

- Modules should be firmly fixed in place in a manner suitable to withstand all expected loads, including wind and snow loads.
- Metals used in locations that are exposed to moisture shall not be employed alone or in combinations that could result in deterioration or corrosion.

USE OF RAILS AND CLAMPS

Installing the EverVolt modules with clamps and rails has been found to comply with UL 61730 requirements for downward pressure, e.g., snow, of up to 7000 Pa (4666 Pa design load*) and upward pressure, e.g., wind, of up to 4000 Pa (2666 Pa design load*) according to the following instructions (*design loads apply a safety factor of 1.5 to the stated test load, e.g., test load 7000 Pa / 1.5 = 4666 Pa design load).

When installing on mounting rails, ensure they run underneath the module and provide support to the frame. The positioning of the rail must ensure that the minimum clamp grip length and the central point of the fixation, e.g., the bolt, is fully within the required clamping zone as indicated on the following pages.

EverVolt modules must be secured with a torque between 8.8-18.4 ft-lb (12 - 25 Nm). Clamp installation

must be carried out according to the manufacturer's instructions, including specific hardware and torque requirements. Ensure the clamps used are suitable for the planned installation and expected system design loads.

- The grip area must not extend onto the module glass and/or cause cell shading.
- Avoid the application of excessive pressure to prevent frame deformation.
- The module must be secured, e.g., clamped, at least once in each of the four marked zones shown below (Figure. 8).

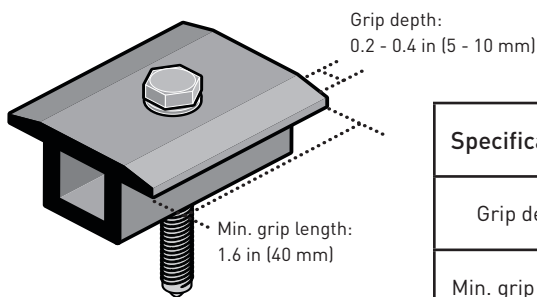

Figure 7. Clamp specifications

Specifications	Length
Grip depth	0.2 - 0.4in (5-10mm)
Min. grip length	1.6in (40mm)
Torque	See manufacturer's instructions

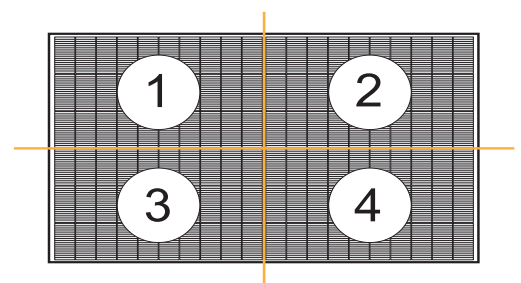

Figure 8. Module quarter division

INSTALLATION OF EVPVXXX AND EVPVXXXK SERIES MODULES

MOUNTING EVPXXX SERIES AND EVPVXXXK SERIES WITH CONTINUOUS RAILS PARALLEL TO SHORT SIDE OF THE MODULE

A continuous rail spans the complete underside of the module.

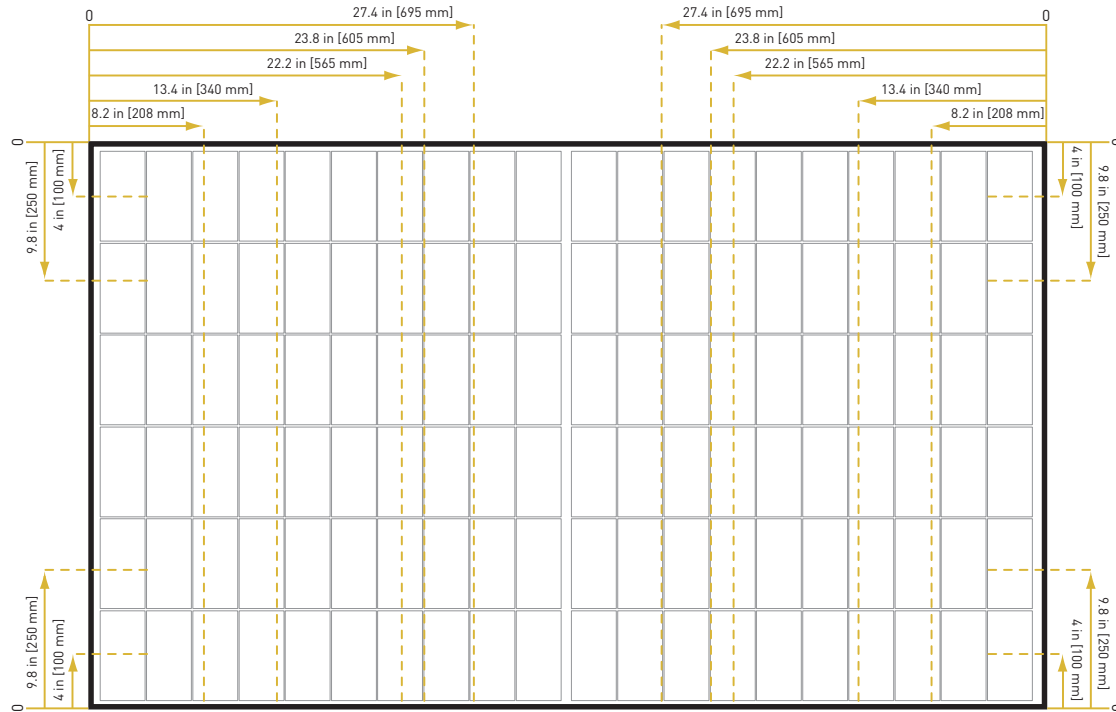

Figure 9. Clamping of EVPVxxx and EVPVxxxK Series modules with rails parallel to short side of the module

Legend	Clearance Gap**	Clamping zone	0.8 - 1.6 in [20-40 mm]	1.6 - 2.4 in [40-60 mm]	>2.4 in (>60 mm)	<0.8 in (<20 mm)
			Test Load (Design Load)	Test Load (Design Load)	Test Load (Design Load)	Test Load (Design Load)
Rail position 	Long Side Mounting	0 - 8.2 in [0 - 208 mm]	X	+1200 Pa / -1200 Pa* (+800 Pa / -800 Pa)	+2400 Pa / -2400 Pa (+1600 Pa / -1600 Pa)	X
		8.2 - 13.4 in [208 - 340 mm]	+1800 Pa / -1800 Pa* (+1200 Pa / -1200 Pa)	+4200 Pa / -2400 Pa (+2800 Pa / -1600 Pa)	+5400 Pa / -2400 Pa (+3600 Pa / -1600 Pa)	X
		13.4 - 22.2 in [340 - 565 mm]	+1800 Pa / -1800 Pa* (+1200 Pa / -1200 Pa)	+6200 Pa / -4000 Pa (+4133 Pa / -2666 Pa)	+7000 Pa / -4000 Pa (+4666 Pa / -2666 Pa)	X
		22.2 - 23.8 in [565 - 605 mm]	+1200 Pa / -1200 Pa* (+800 Pa / -800 Pa)	+3000 Pa / -2400 Pa (+2400 Pa / -1600 Pa)	+5400 Pa / -2400 Pa (+3600 Pa / -1600 Pa)	X
		23.8 - 27.4 in [605 - 695 mm]	+2400 Pa / -2400 Pa (+1600 Pa / -1600 Pa)	+2400 Pa / -2400 Pa (+1600 Pa / -1600 Pa)	+2400 Pa / -2400 Pa (+1600 Pa / -1600 Pa)	X
Rail position 	Short Side Mounting	0 - 4 in [0 - 100 mm]	X	+1200 Pa / -1200 Pa* (+800 Pa / -800 Pa)	+1600 Pa / -1600 Pa* (+1066 Pa / -1066 Pa)	X
		4 - 9.8 in [100 - 250 mm]	X	+800 Pa / -800 Pa* (+533 Pa / -533 Pa)	+2400 Pa / -2400 Pa (+1600 Pa / -1600 Pa)	X
		Once a module is secured in each of the 4 zones (Figure 8.), additional clamps, i.e., ≥5 may be freely located on panel frame without affecting the warranty. Loads marked with a * were not certified as part of UL 61730 testing; these have been evaluated by internal testing process.				

**Gap between the uppermost part of the installation surface(e.g. rooftop) and the lowest part of the panel (i.e. underside of panel frame)



CAUTION

The center point of each clamp and the minimum grip length must be fully located in the same clamping zones to be rated to that load (Figure 9). If the panel is secured in zones with different load values, it is rated to the lowest load value only.

MOUNTING EVPVXXX AND EVPVXXXK SERIES WITH CONTINUOUS RAILS PARALLEL TO LONG SIDE OF THE MODULE

A continuous rail spans the complete underside of the module.

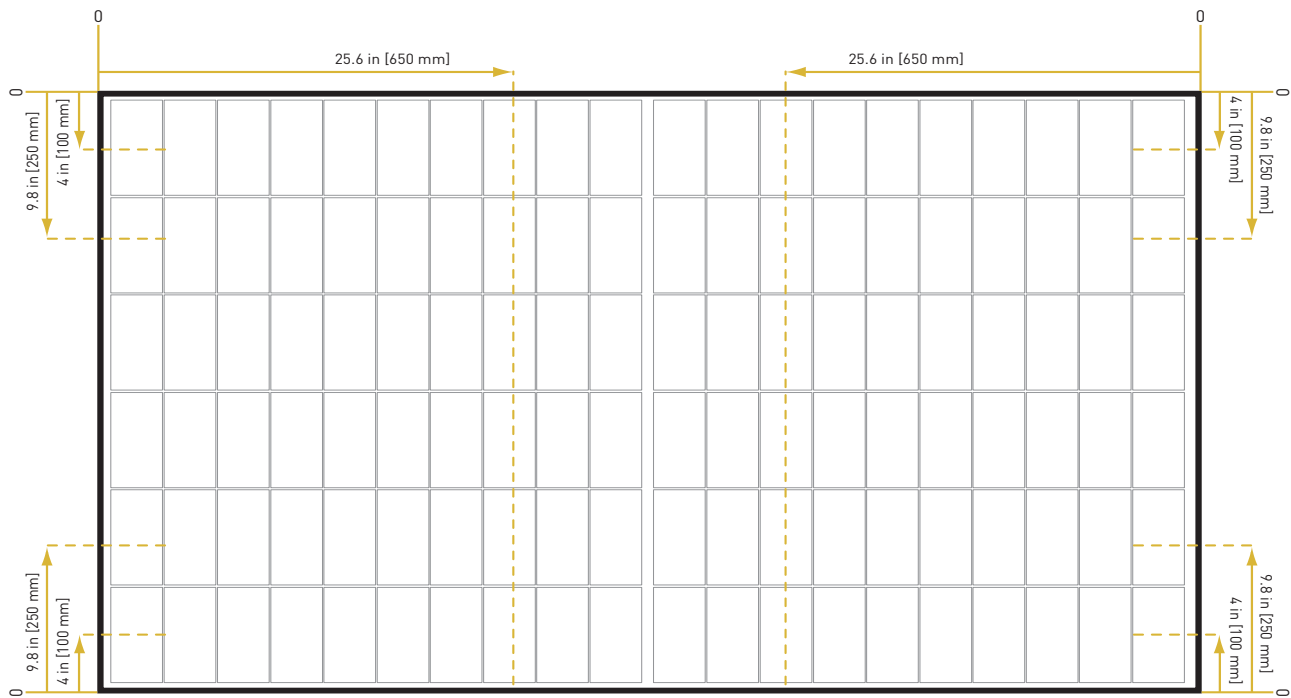

Figure 10. Clamping of EVPVxxx and EVPVxxxK Series modules with rails parallel to long side of the module

Legend	Clearance Gap**		0.8 - 1.6 in (20-40 mm)	1.6 - 2.4 in (40-60 mm)	>2.4 in (>60 mm)	<0.8 in (<20 mm)
			Test Load (Design Load)	Test Load (Design Load)	Test Load (Design Load)	Test Load (Design Load)
	Long Side Mounting	0 - 25.6 in (0 - 650 mm)	+1200 Pa / -1200 Pa * (+800 Pa / -800 Pa)	+3000 Pa / -2400 Pa (+2400 Pa / -1600 Pa)	+5400 Pa / -2400 Pa (+3600 Pa / -1600 Pa)	X
		0 - 4 in (0 - 100 mm)	X	+1200 Pa / -1200 Pa * (+800 Pa / -800 Pa)	+1600 Pa / -1600 Pa * (+1066 Pa / -1066 Pa)	X
		4 - 9.8 in (100 - 250 mm)	X	+800 Pa / -800 Pa * (+533 Pa / -533 Pa)	+2400 Pa / -2400 Pa (+1600 Pa / -1600 Pa)	X
	Once a module is secured in each of the 4 zones (Figure 8.), additional clamps, i.e., >5 may be freely located on panel frame without affecting the warranty. Loads marked with a * were not certified as part of UL 61730 testing; these have been evaluated by internal testing process.					

**Gap between the uppermost part of the installation surface (e.g. rooftop) and the lowest part of the panel (i.e. underside of panel frame)



CAUTION

The center point of each clamp and the minimum grip length must be fully located in the same clamping zones to be rated to that load (Figure 10).

If the panel is secured in zones with different load values, it is rated to the lowest load value only.

MOUNTING EVPVXXX AND EVPVXXXK SERIES WITH SHORT RAILS

A short rail is a rail with a min. length of 2 in [50 mm] that does not span the complete underside of a module.

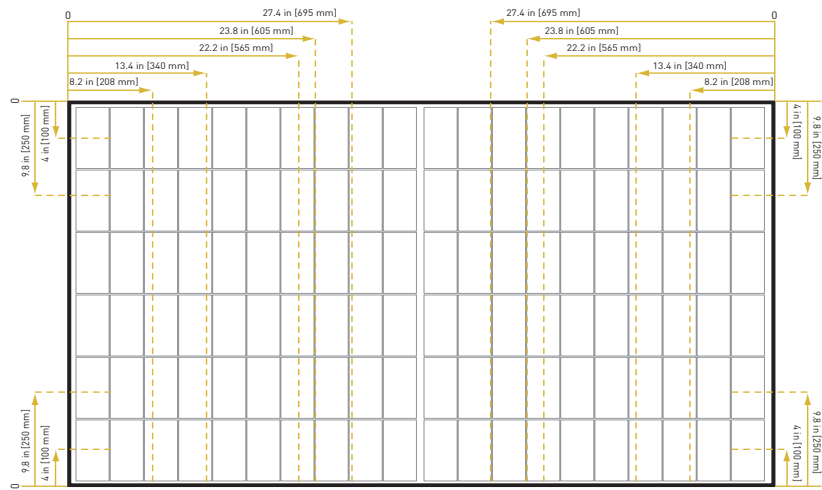

Figure 11. Clamping of EVPVxxx and EVPVxxxK Series modules using short rails

Legend	Clearance Gap**		0.8 - 1.6 in [20-40 mm]	1.6 - 2.4 in [40-60 mm]	>2.4 in [>60 mm]	<0.8 in [<20 mm]	
			Test Load (Design Load)	Test Load (Design Load)	Test Load (Design Load)	Test Load (Design Load)	
Rail length under module 1 - 4 in 	Long Side Mounting	0 - 8.2 in [0 - 208 mm]	X	+1200 Pa / -1200 Pa* [+800 Pa / -800 Pa]	+1600 Pa / -1600 Pa* [+1066 Pa / -1066 Pa]	X	
		8.2 - 13.4 in [208 - 340 mm]	+1200 Pa / -1200 Pa* [+800 Pa / -800 Pa]	+4100 Pa / -2400 Pa [+2733 Pa / -1600 Pa]	+4500 Pa / -2400 Pa [+3000 Pa / -1600 Pa]	X	
		13.4 - 22.2 in [340 - 565 mm]	+1200 Pa / -1200 Pa* [+800 Pa / -800 Pa]	+3000 Pa / -3000 Pa [+2000 Pa / -2000 Pa]	+4200 Pa / -4000 Pa [+2800 Pa / -2666 Pa]	X	
		22.2 - 23.8 in [565 - 605 mm]	+1200 Pa / -1200 Pa* [+800 Pa / -800 Pa]	+2400 Pa / -2400 Pa [+1600 Pa / -1600 Pa]	+3600 Pa / -2400 Pa [+2400 Pa / -1600 Pa]	X	
		23.8 - 27.4 in [605 - 695 mm]	+1800 Pa / -1800 Pa* [+1200 Pa / -1200 Pa]	+2400 Pa / -2400 Pa [+1600 Pa / -1600 Pa]	+2400 Pa / -2400 Pa [+1600 Pa / -1600 Pa]	X	
	Short Side Mounting	0 - 4 in [0 - 100 mm]	X	+1200 Pa / -1200 Pa* [+800 Pa / -800 Pa]	+1600 Pa / -1600 Pa* [+1066 Pa / -1066 Pa]	X	
		4 - 9.8 in [100 - 250 mm]	X	+800 Pa / -800 Pa* [+533 Pa / -533 Pa]	+2400 Pa / -2400 Pa [+1600 Pa / -1600 Pa]	X	
	Rail length under module 4 - 7.9 in 	Long Side Mounting	0 - 8.2 in [0 - 208 mm]	X	+1200 Pa / -1200 Pa* [+800 Pa / -800 Pa]	+1600 Pa / -1600 Pa* [+1066 Pa / -1066 Pa]	X
			8.2 - 13.4 in [208 - 340 mm]	+1200 Pa / -1200 Pa* [+800 Pa / -800 Pa]	+3600 Pa / -2400 Pa [+2400 Pa / -1600 Pa]	+3600 Pa / -2400 Pa [+2400 Pa / -1600 Pa]	X
			13.4 - 22.2 in [340 - 565 mm]	+1200 Pa / -1200 Pa* [+800 Pa / -800 Pa]	+3000 Pa / -3000 Pa [+2000 Pa / -2000 Pa]	+3000 Pa / -3000 Pa [+2000 Pa / -2000 Pa]	X
22.2 - 23.8 in [565 - 605 mm]			+1200 Pa / -1200 Pa* [+800 Pa / -800 Pa]	+2400 Pa / -2400 Pa [+1600 Pa / -1600 Pa]	+3600 Pa / -2400 Pa [+2400 Pa / -1600 Pa]	X	
23.8 - 27.4 in [605 - 695 mm]			+1800 Pa / -1800 Pa* [+1200 Pa / -1200 Pa]	+2400 Pa / -2400 Pa [+1600 Pa / -1600 Pa]	+2400 Pa / -2400 Pa [+1600 Pa / -1600 Pa]	X	
Short Side Mounting		0 - 4 in [0 - 100 mm]	X	+1200 Pa / -1200 Pa* [+800 Pa / -800 Pa]	+1600 Pa / -1600 Pa* [+1066 Pa / -1066 Pa]	X	
		4 - 9.8 in [100 - 250 mm]	X	+800 Pa / -800 Pa* [+533 Pa / -533 Pa]	+2400 Pa / -2400 Pa [+1600 Pa / -1600 Pa]	X	
		Once a module is secured in each of the 4 zones (Figure 8), additional clamps, i.e., ≥5 may be freely located on panel frame without affecting the warranty. Loads marked with a * were not certified as part of UL 61730 testing; these have been evaluated by internal testing process.					

**Gap between the uppermost part of the installation surface (e.g. rooftop) and the lowest part of the panel (i.e. underside of panel frame)

INSTALLATION OF EVPVXXXH AND EVPVXXXHK SERIES MODULES

MOUNTING EVPVXXXH AND EVPVXXXHK SERIES MODULES WITH CONTINUOUS RAILS PARALLEL TO SHORT SIDE OF THE MODULE

A continuous rail (or other support structure) spans the complete underside of the module.

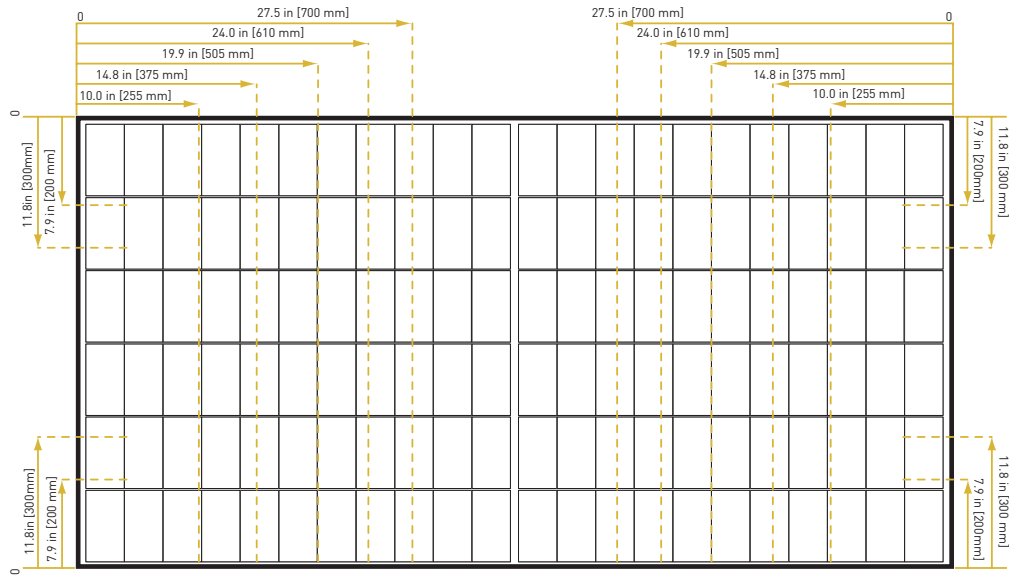

Figure 12. Clamping of EVPVxxxH and EVPVxxxHK Series modules with rails parallel to short side of the module

Legend	Clearance Gap**		0.8 - 1.6 in (20-40 mm)	1.6 - 2.4 in (40-60 mm)	>2.4 in (>60 mm)	<0.8 in (<20 mm)
			Test Load (Design Load)	Test Load (Design Load)	Test Load (Design Load)	Test Load (Design Load)
 Rail position	Long Side Mounting	0 - 10.0 in (0 - 255 mm)	X	+1200 Pa / -1200 Pa* (+800 Pa / -800 Pa)	+2400 Pa / -2400 Pa* (+1600 Pa / -1600 Pa)	X
		10.0 - 14.8 in (255 - 375 mm)	+1800 Pa / -1800 Pa* (+1200 Pa / -1200 Pa)	+4200 Pa / -2400 Pa (+2800 Pa / -1600 Pa)	+5400 Pa / -2400 Pa (+3600 Pa / -1600 Pa)	X
		14.8 - 19.9 in (375 - 505 mm)	+1800 Pa / -1800 Pa* (+1200 Pa / -1200 Pa)	+6200 Pa / -4000 Pa (+4133 Pa / -2666 Pa)	+7000 Pa / -4000 Pa (+4666 Pa / -2666 Pa)	X
		15.9 - 24.0 in (505 - 610 mm)	+1200 Pa / -1200 Pa* (+800 Pa / -800 Pa)	+3000 Pa / -2400 Pa (+2400 Pa / -1600 Pa)	+5400 Pa / -2400 Pa (+3600 Pa / -1600 Pa)	X
		24.0 - 27.5 in (610 - 700 mm)	+2400 Pa / -2400 Pa* (+1600 Pa / -1600 Pa)	+2400 Pa / -2400 Pa (+1600 Pa / -1600 Pa)	+2400 Pa / -2400 Pa (+1600 Pa / -1600 Pa)	X
 Rail position	Short Side Mounting	0 - 7.9 in (0 - 200 mm)	X	+1200 Pa / -1200 Pa* (+800 Pa / -800 Pa)	+1600 Pa / -1600 Pa* (+1066 Pa / -1066 Pa)	X
		7.9 - 11.8 in (200 - 300 mm)	X	+800 Pa / -800 Pa* (+533 Pa / -533 Pa)	+2400 Pa / -2400 Pa (+1600 Pa / -1600 Pa)	X



Once a module is secured in each of the 4 zones (Figure 8.), additional clamps, i.e., >5, may be freely located on panel frame without affecting the warranty. Loads marked with a * were not certified as part of UL 61730 testing; these have been evaluated by internal testing process.

**Gap between the uppermost part of the installation surface (e.g. rooftop) and the lowest part of the panel (i.e. underside of panel frame)



CAUTION

The center point of each clamp and the minimum grip length must be fully located in the same clamping zones to be rated to that load (Figure 12.).

If the panel is secured in zones with different load values, it is rated to the lowest load value only.

MOUNTING EVPVXXXH AND EVPVXXXHK SERIES MODULES WITH CONTINUOUS RAILS PARALLEL TO LONG SIDE OF THE MODULE

A continuous rail (or other support structure) spans the complete underside of the module.

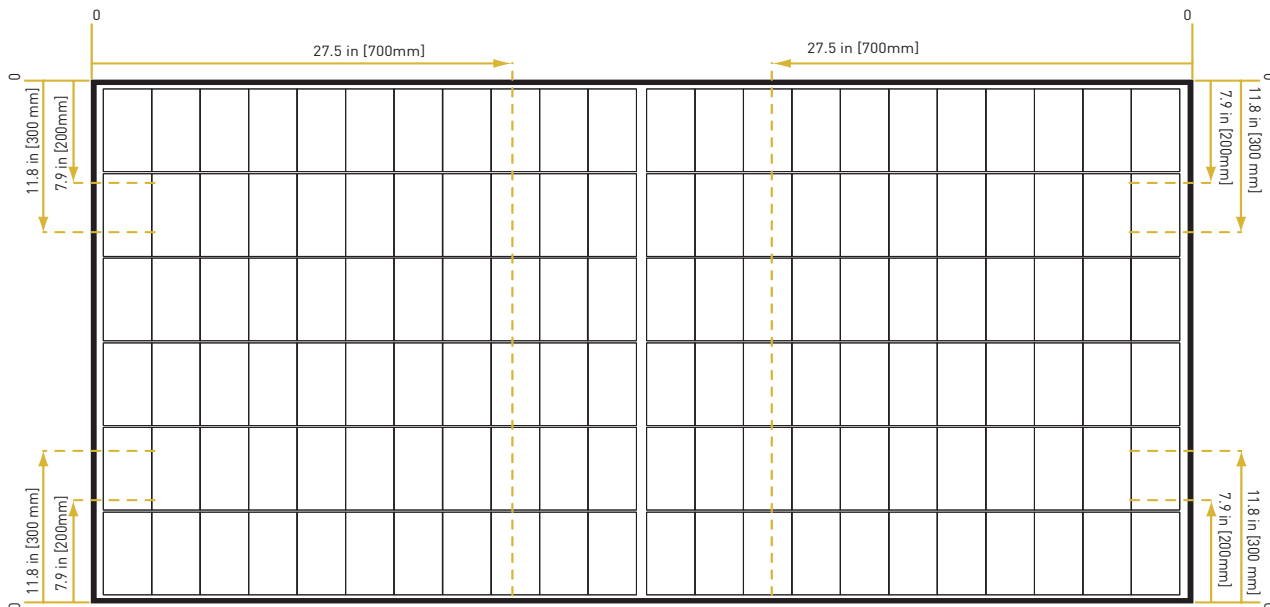

Figure 13. Clamping of EVPVxxxH and EVPVxxxHK Series modules with rails parallel to long side of the module

Legend	Clearance Gap**		0.8 - 1.6 in (20-40 mm)	1.6 - 2.4 in (40-60 mm)	>2.4 in (>60 mm)	<0.8 in (<20 mm)
			Test Load (Design Load)	Test Load (Design Load)	Test Load (Design Load)	Test Load (Design Load)
	Long Side Mounting	0 - 27.5 in (0 - 700 mm)	+1200 Pa / -1200 Pa * (+800 Pa / -800 Pa)	+3000 Pa / -2400 Pa (+2400 Pa / -1600 Pa)	+5400 Pa / -2400 Pa (+3600 Pa / -1600 Pa)	X
		0 - 7.9 in (0 - 200 mm)	X	+1200 Pa / -1200 Pa * (+800 Pa / -800 Pa)	+1600 Pa / -1600 Pa * (+1066 Pa / -1066 Pa)	X
		7.9 - 11.8 in (200 - 300 mm)	X	+800 Pa / -800 Pa * (+533 Pa / -533 Pa)	+2400 Pa / -2400 Pa (+1600 Pa / -1600 Pa)	X
	Once a module is secured in each of the 4 zones (Figure 8.), additional clamps, i.e., >5 may be freely located on panel frame without affecting the warranty. Loads marked with a * were not certified as part of UL 61730 testing; these have been evaluated by internal testing process.					

**Gap between the uppermost part of the installation surface (e.g. rooftop) and the lowest part of the panel (i.e. underside of panel frame)



CAUTION

The center point of each clamp and the minimum grip length must be fully located in the same clamping zones to be rated to that load (Figure 13).

If the panel is secured in zones with different load values, it is rated to the lowest load value only.

MOUNTING EVPVXXXH AND EVPVXXXHK SERIES MODULES WITH SHORT RAILS

A short rail (or other short support structure) has a minimum length of 25 mm and does not span the complete underside of a module.

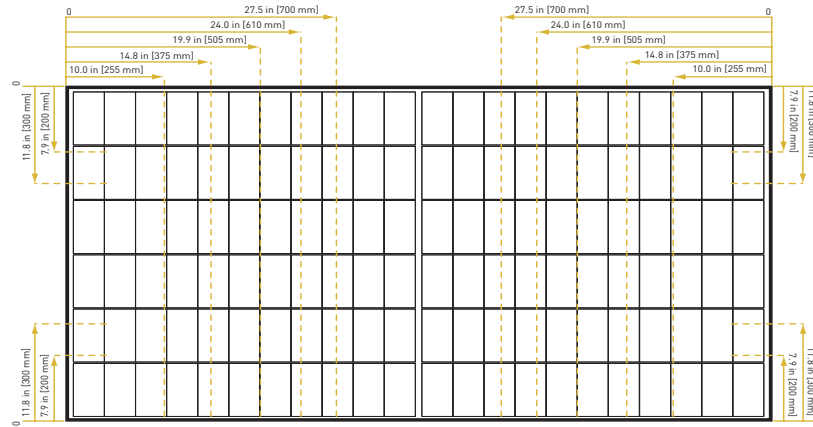

Figure 14. Clamping of EVPVxxxH and EVPVxxxHK Series modules using short rails

Legend	Clearance Gap**		0.8 - 1.6 in (20-40 mm)	1.6 - 2.4 in (40-60 mm)	>2.4 in (>60 mm)	<0.8 in (<20 mm)
			Test Load (Design Load)	Test Load (Design Load)	Test Load (Design Load)	Test Load (Design Load)
Rail length under module 1 - 3.9 in (25 - 100 mm) 	Long Side Mounting	0 - 10.0 in (0 - 255 mm)	X	+1200 Pa / -1200 Pa* (+800 Pa / -800 Pa)	+1600 Pa / -1600 Pa* (+1066 Pa / -1066 Pa)	X
		10.0 - 14.8 in (255 - 375 mm)	+1200 Pa / -1200 Pa* (+800 Pa / -800 Pa)	+4100 Pa / -2400 Pa (+2733 Pa / -1600 Pa)	+4500 Pa / -2400 Pa (+3000 Pa / -1600 Pa)	X
		14.8 - 19.9 in (375 - 505 mm)	+1200 Pa / -1200 Pa* (+800 Pa / -800 Pa)	+3000 Pa / -3000 Pa (+2000 Pa / -2000 Pa)	+4200 Pa / -4000 Pa (+2800 Pa / -2666 Pa)	X
		15.9 - 24.0 in (505 - 610 mm)	+1200 Pa / -1200 Pa* (+800 Pa / -800 Pa)	+2400 Pa / -2400 Pa (+1600 Pa / -1600 Pa)	+3600 Pa / -2400 Pa (+2400 Pa / -1600 Pa)	X
		24.0 - 27.5 in (610 - 700 mm)	+1800 Pa / -1800 Pa* (+1200 Pa / -1200 Pa)	+2400 Pa / -2400 Pa (+1600 Pa / -1600 Pa)	+2400 Pa / -2400 Pa (+1600 Pa / -1600 Pa)	X
	Short Side Mounting	0 - 7.9 in (0 - 200 mm)	X	+1200 Pa / -1200 Pa* (+800 Pa / -800 Pa)	+1600 Pa / -1600 Pa* (+1066 Pa / -1066 Pa)	X
	7.9 - 11.8 in (200 - 300 mm)	X	+800 Pa / -800 Pa* (+533 Pa / -533 Pa)	+2400 Pa / -2400 Pa (+1600 Pa / -1600 Pa)	X	
Rail length under module 3.9 - 7.9 in (100 - 200 mm) 	Long Side Mounting	0 - 10.0 in (0 - 255 mm)	X	+1200 Pa / -1200 Pa* (+800 Pa / -800 Pa)	+1600 Pa / -1600 Pa* (+1066 Pa / -1066 Pa)	X
		10.0 - 14.8 in (255 - 375 mm)	+1200 Pa / -1200 Pa* (+800 Pa / -800 Pa)	+3600 Pa / -2400 Pa (+2400 Pa / -1600 Pa)	+3600 Pa / -2400 Pa (+2400 Pa / -1600 Pa)	X
		14.8 - 19.9 in (375 - 505 mm)	+1200 Pa / -1200 Pa* (+800 Pa / -800 Pa)	+3000 Pa / -3000 Pa (+2000 Pa / -2000 Pa)	+3000 Pa / -3000 Pa (+2000 Pa / -2000 Pa)	X
		15.9 - 24.0 in (505 - 610 mm)	+1200 Pa / -1200 Pa* (+800 Pa / -800 Pa)	+2400 Pa / -2400 Pa (+1600 Pa / -1600 Pa)	+3600 Pa / -2400 Pa (+2400 Pa / -1600 Pa)	X
		24.0 - 27.5 in (610 - 700 mm)	+1800 Pa / -1800 Pa* (+1200 Pa / -1200 Pa)	+2400 Pa / -2400 Pa (+1600 Pa / -1600 Pa)	+2400 Pa / -2400 Pa (+1600 Pa / -1600 Pa)	X
	Short Side Mounting	0 - 7.9 in (0 - 200 mm)	X	+1200 Pa / -1200 Pa* (+800 Pa / -800 Pa)	+1600 Pa / -1600 Pa* (+1066 Pa / -1066 Pa)	X
	7.9 - 11.8 in (200 - 300 mm)	X	+800 Pa / -800 Pa* (+533 Pa / -533 Pa)	+2400 Pa / -2400 Pa (+1600 Pa / -1600 Pa)	X	
	Once a module is secured in each of the 4 zones (Figure 8), additional clamps, i.e., ≥5 may be freely located on panel frame without affecting the warranty. Loads marked with a * were not certified as part of UL 61730 testing; these have been evaluated by internal testing process.					

**Gap between the uppermost part of the installation surface (e.g. rooftop) and the lowest part of the panel (i.e. underside of panel frame)



CAUTION

The center point of each clamp and the minimum grip length must be fully located in the same clamping zones to be rated to that load (Figure 14.). If the panel is secured in zones with different load values, it is rated to the lowest load value only.

INSTALLATION OF EVPXXXXPK SERIES MODULES

MOUNTING EVPXXXXPK SERIES MODULES WITH CONTINUOUS RAILS PARALLEL TO SHORT SIDE OF THE MODULE

A continuous rail (or other support structure) spans the complete underside of the module.

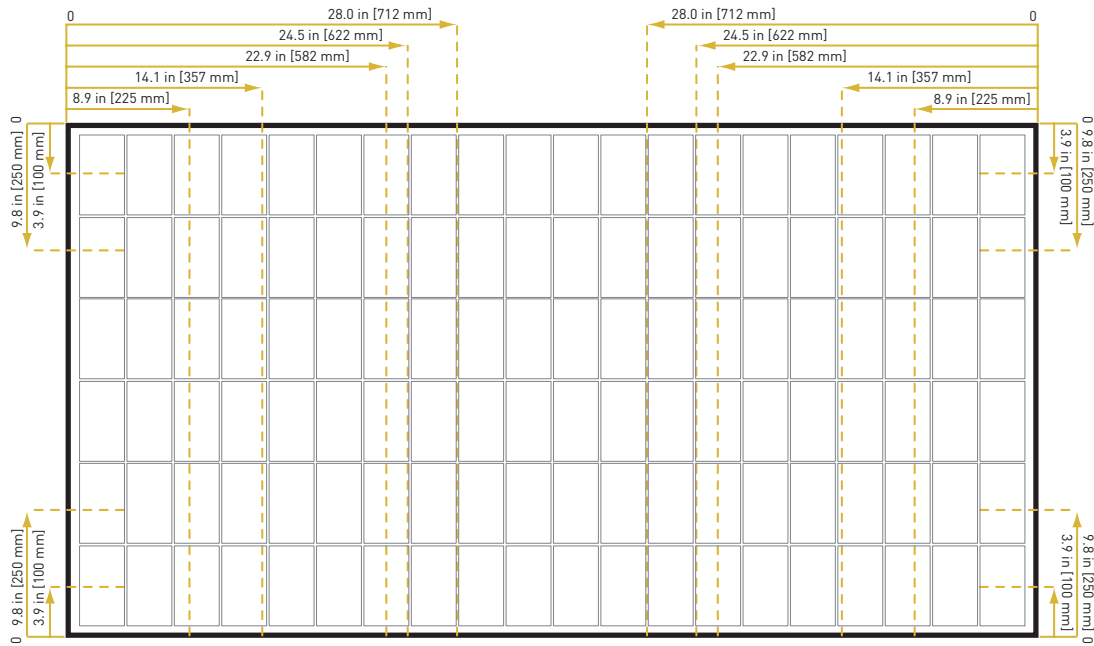

Figure 15. Clamping of EVPxxxxPK Series modules with rails parallel to short side of the module

Legend	Clamping zone	Clearance Gap**				
		0.8 - 1.6 in (20-40 mm)	1.6 - 2.4 in (40-60 mm)	>2.4 in (>60 mm)	<0.8 in (<20 mm)	
		Test Load (Design Load)	Test Load (Design Load)	Test Load (Design Load)	Test Load (Design Load)	
 Rail position	Long Side Mounting	0 - 8.9 in (0 - 225 mm)	X	+1200 Pa / -1200 Pa* (+800 Pa / -800 Pa)	+2400 Pa / -2400 Pa* (+1600 Pa / -1600 Pa)	X
		8.9 - 14.1 (225 - 357 mm)	+1800 Pa / -1800 Pa* (+1200 Pa / -1200 Pa)	+4200 Pa / -2400 Pa (+2800 Pa / -1600 Pa)	+5400 Pa / -2400 Pa (+3600 Pa / -1600 Pa)	X
		14.1 - 22.9 in (357 - 582 mm)	+1800 Pa / -1800 Pa* (+1200 Pa / -1200 Pa)	+6200 Pa / -4000 Pa (+4133 Pa / -2666 Pa)	+7000 Pa / -4000 Pa (+4666 Pa / -2666 Pa)	X
		22.9 - 24.5 in (582 - 622 mm)	+1200 Pa / -1200 Pa* (+800 Pa / -800 Pa)	+3000 Pa / -2400 Pa (+2400 Pa / -1600 Pa)	+5400 Pa / -2400 Pa (+3600 Pa / -1600 Pa)	X
		24.5 - 28.0 in (622 - 712 mm)	+2400 Pa / -2400 Pa* (+1600 Pa / -1600 Pa)	+2400 Pa / -2400 Pa (+1600 Pa / -1600 Pa)	+2400 Pa / -2400 Pa (+1600 Pa / -1600 Pa)	X
 Rail position	Short Side Mounting	0 - 4 in (0 - 100 mm)	X	+1200 Pa / -1200 Pa* (+800 Pa / -800 Pa)	+1600 Pa / -1600 Pa* (+1066 Pa / -1066 Pa)	X
		4 - 9.8 in (100 - 250 mm)	X	+800 Pa / -800 Pa* (+533 Pa / -533 Pa)	+2400 Pa / -2400 Pa (+1600 Pa / -1600 Pa)	X
		Once a module is secured in each of the 4 zones (Figure 8.), additional clamps, i.e., >5, may be freely located on panel frame without affecting the warranty. Loads marked with a * were not certified as part of UL 61730 testing; these have been evaluated by internal testing process.				

**Gap between the uppermost part of the installation surface (e.g. rooftop) and the lowest part of the panel (i.e. underside of panel frame)



CAUTION

The center point of each clamp and the minimum grip length must be fully located in the same clamping zones to be rated to that load (Figure 15.).

If the panel is secured in zones with different load values, it is rated to the lowest load value only.

MOUNTING EVPXXXXPK SERIES MODULES WITH CONTINUOUS RAILS PARALLEL TO LONG SIDE OF THE MODULE
 A continuous rail (or other support structure) spans the complete underside of the module.

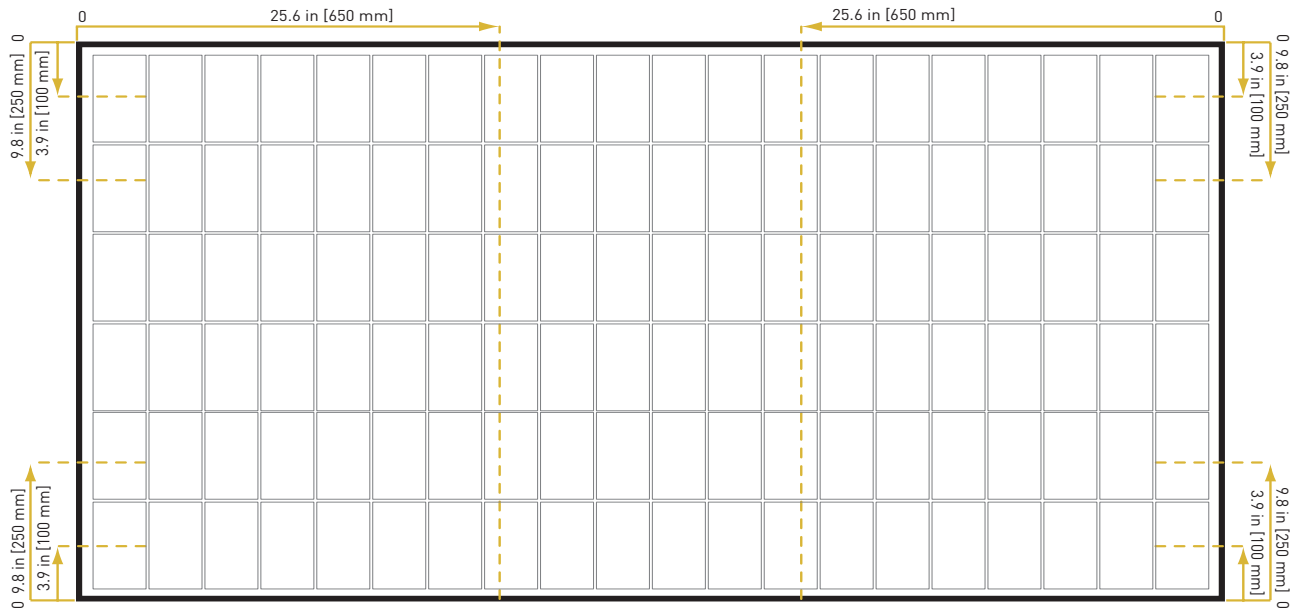

Figure 16. Clamping of EVPxxxxPK Series modules with rails parallel to long side of the panel

Legend	Clearance Gap**		0.8 - 1.6 in (20-40 mm)	1.6 - 2.4 in (40-60 mm)	>2.4 in (>60 mm)	<0.8 in (<20 mm)
			Test Load (Design Load)	Test Load (Design Load)	Test Load (Design Load)	Test Load (Design Load)
	Long Side Mounting	0 - 25.6 in (0 - 650 mm)	+1200 Pa / -1200 Pa * (+800 Pa / -800 Pa)	+3000 Pa / -2400 Pa (+2400 Pa / -1600 Pa)	+5400 Pa / -2400 Pa (+3600 Pa / -1600 Pa)	X
		0 - 4 in (0 - 100 mm)	X	+1200 Pa / -1200 Pa * (+800 Pa / -800 Pa)	+1600 Pa / -1600 Pa * (+1066 Pa / -1066 Pa)	X
		4 - 9.8 in (100-250 mm)	X	+800 Pa / -800 Pa * (+533 Pa / -533 Pa)	+2400 Pa / -2400 Pa (+1600 Pa / -1600 Pa)	X
	Once a module is secured in each of the 4 zones (Figure 8.), additional clamps, i.e., >5 may be freely located on panel frame without affecting the warranty. Loads marked with a * were not certified as part of UL 61730 testing; these have been evaluated by internal testing process.					

**Gap between the uppermost part of the installation surface(e.g. rooftop) and the lowest part of the panel (i.e. underside of panel frame)



CAUTION

The center point of each clamp and the minimum grip length must be fully located in the same clamping zones to be rated to that load (Figure 16).
 If the panel is secured in zones with different load values, it is rated to the lowest load value only.

MOUNTING EVPXXXXPK SERIES MODULES WITH SHORT RAILS

A short rail (or other short support structure) has a minimum length of 25 mm and does not span the complete underside of a module.

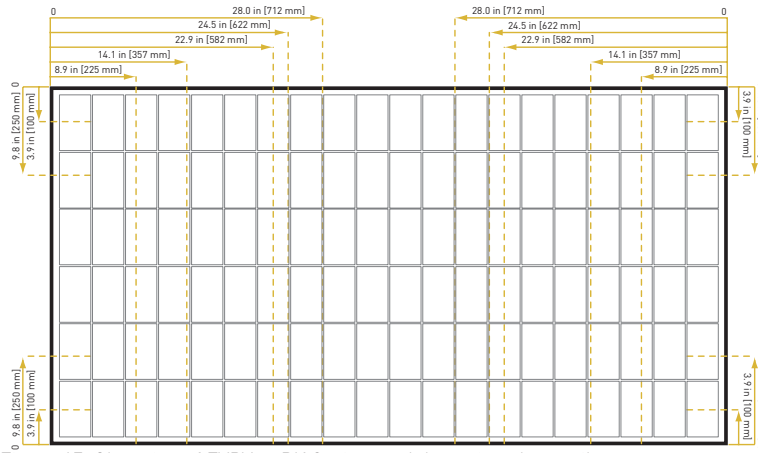
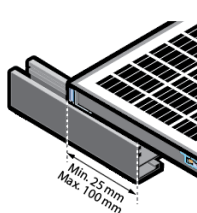
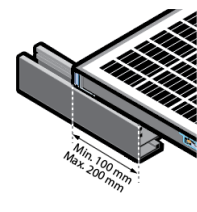



Figure 17. Clamping of EVPxxxxPK Series modules using short rails

Legend	Clearance Gap**		0.8 - 1.6 in (20-40 mm)	1.6 - 2.4 in (40-60 mm)	>2.4 in (>60 mm)	<0.8 in (<20 mm)
			Test Load (Design Load)	Test Load (Design Load)	Test Load (Design Load)	Test Load (Design Load)
Rail length under module 1 - 3.9 in (25 - 100 mm) 	Long Side Mounting	0 - 8.9 in (0 - 225 mm)	X	+1200 Pa / -1200 Pa* (+800 Pa / -800 Pa)	+1600 Pa / -1600 Pa* (+1066 Pa / -1066 Pa)	X
		8.9 - 14.1 in (225 - 357 mm)	+1200 Pa / -1200 Pa* (+800 Pa / -800 Pa)	+4100 Pa / -2400 Pa (+2733 Pa / -1600 Pa)	+4500 Pa / -2400 Pa (+3000 Pa / -1600 Pa)	X
		14.1 - 22.9 in (357 - 582 mm)	+1200 Pa / -1200 Pa* (+800 Pa / -800 Pa)	+3000 Pa / -3000 Pa (+2000 Pa / -2000 Pa)	+4200 Pa / -4000 Pa (+2800 Pa / -2666 Pa)	X
		22.9 - 24.5 in (582 - 622 mm)	+1200 Pa / -1200 Pa* (+800 Pa / -800 Pa)	+2400 Pa / -2400 Pa (+1600 Pa / -1600 Pa)	+3600 Pa / -2400 Pa (+2400 Pa / -1600 Pa)	X
		24.5 - 28.0 in (622 - 712 mm)	+1800 Pa / -1800 Pa* (+1200 Pa / -1200 Pa)	+2400 Pa / -2400 Pa (+1600 Pa / -1600 Pa)	+2400 Pa / -2400 Pa (+1600 Pa / -1600 Pa)	X
	Short Side Mounting	0 - 4 in (0 - 100 mm)	X	+1200 Pa / -1200 Pa* (+800 Pa / -800 Pa)	+1600 Pa / -1600 Pa* (+1066 Pa / -1066 Pa)	X
	4 - 9.8 in (100 - 250 mm)	X	+800 Pa / -800 Pa* (+533 Pa / -533 Pa)	+2400 Pa / -2400 Pa (+1600 Pa / -1600 Pa)	X	
Rail length under module 3.9 - 7.9 in (100 - 200 mm) 	Long Side Mounting	0 - 8.9 in (0 - 225 mm)	X	+1200 Pa / -1200 Pa* (+800 Pa / -800 Pa)	+1600 Pa / -1600 Pa* (+1066 Pa / -1066 Pa)	X
		8.9 - 14.1 in (225 - 357 mm)	+1200 Pa / -1200 Pa* (+800 Pa / -800 Pa)	+3600 Pa / -2400 Pa (+2400 Pa / -1600 Pa)	+3600 Pa / -2400 Pa (+2400 Pa / -1600 Pa)	X
		14.1 - 22.9 in (357 - 582 mm)	+1200 Pa / -1200 Pa* (+800 Pa / -800 Pa)	+3000 Pa / -3000 Pa (+2000 Pa / -2000 Pa)	+3000 Pa / -3000 Pa (+2000 Pa / -2000 Pa)	X
		22.9 - 24.5 in (582 - 622 mm)	+1200 Pa / -1200 Pa* (+800 Pa / -800 Pa)	+2400 Pa / -2400 Pa (+1600 Pa / -1600 Pa)	+3600 Pa / -2400 Pa (+2400 Pa / -1600 Pa)	X
		24.5 - 28.0 in (622 - 712 mm)	+1800 Pa / -1800 Pa* (+1200 Pa / -1200 Pa)	+2400 Pa / -2400 Pa (+1600 Pa / -1600 Pa)	+2400 Pa / -2400 Pa (+1600 Pa / -1600 Pa)	X
	Short Side Mounting	0 - 4 in (0 - 100 mm)	X	+1200 Pa / -1200 Pa* (+800 Pa / -800 Pa)	+1600 Pa / -1600 Pa* (+1066 Pa / -1066 Pa)	X
	4 - 9.8 in (100 - 250 mm)	X	+800 Pa / -800 Pa* (+533 Pa / -533 Pa)	+2400 Pa / -2400 Pa (+1600 Pa / -1600 Pa)	X	
	Once a module is secured in each of the 4 zones (Figure 8), additional clamps, i.e., ≥5 may be freely located on panel frame without affecting the warranty. Loads marked with a * were not certified as part of UL 61730 testing; these have been evaluated by internal testing process.					

**Gap between the uppermost part of the installation surface (e.g. rooftop) and the lowest part of the panel (i.e. underside of panel frame)



CAUTION

The center point of each clamp and the minimum grip length must be fully located in the same clamping zones to be rated to that load (Figure 17). If the panel is secured in zones with different load values, it is rated to the lowest load value only.

**MOUNTING METHODS:
MOUNTING HOLES**

EverVolt modules can be installed utilizing the four mounting holes 0.4 x 0.25 in (11 x 6.6 mm) on the underside of the module [Figure 18 & 19] in conjunction with a device, e.g., screws, lockbolts or structural blind fasteners, with specifications suitable for the installation (Figure 20).

Installing the EverVolt modules using the mounting holes has been found to comply with UL 61730 requirements for downward pressure, e.g., snow, of up to 5400 Pa (3600 Pa design load*) and upward pressure, e.g., wind, of up to 2400 Pa (1600 Pa design load*) according to the following instructions [*design loads apply a safety factor of 1.5 to the stated test load, e.g., test load 5400 Pa / 1.5 = 3600 Pa design load].

The product warranty will be voided if additional holes are made in the frame. All fixing and fastening materials must

be corrosion resistant.

When installing using mounting holes, the frame and module edge of each module must be supported by two rails of aluminium or galvanized steel suitable for the application and appropriate for the local environment. Observe the following procedures when using mounting holes:

- The mounting construction must be of a corrosion resistant material, e.g., aluminum or galvanized steel, and appropriate for the local environment.
- All four mounting holes in the frame must be used (Figure 21).
- Additional electrical bonding to Ground is required for the support structure,
- Refer to the fixing device manufacturer’s installation instructions for preload or torque values.
- Do not contact a tip of a mounting

bolt to back sheet of the module when fixing the module to the mounting structure rail.

- EverVolt modules must be secured with a torque between 8.8-18.4 ft-lb (12 - 25 Nm).
- Module should be attached on a mount or support structure rail by corrosive-resistant metal clamps.
- Appropriate material should be used for mounting hardware (the module frame, mounting structure, and hardware) to prevent itself from corrosion.
- Panasonic does not provide a warranty for clamps. The module warranty Panasonic provides shall be voided if clamps selected by the customer are of an improper material or size.
- Please contact your Panasonic Authorized Representative with questions regarding mounting profiles for modules if needed.

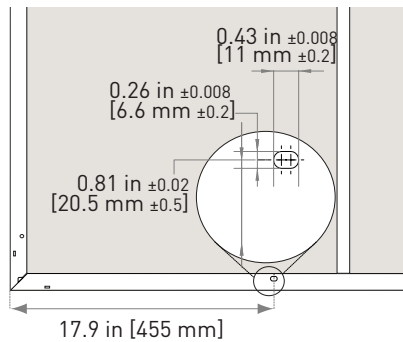

Figure 18. Mounting holes_EVPVxxx, EVPVxxxK, EVPVxxxPK Series modules

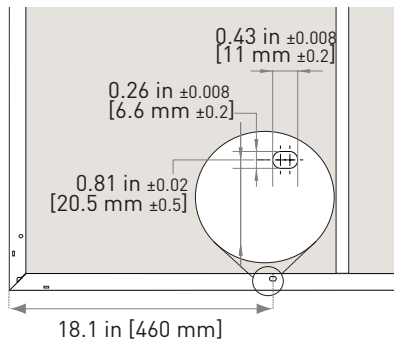

Figure 19. Mounting holes_EVPVxxxH Series modules

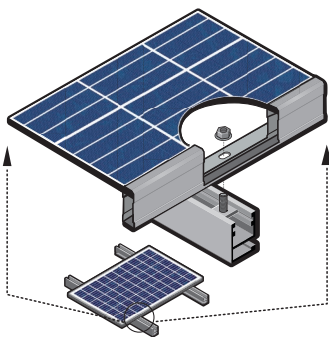

Figure 21. Mounting hole installation example

Part Name	Specification	Material
Rail		6105 - T5 aluminum extrusion
Bolt	1/4" x 20 - 5/8"	ASTM F593 (stainless steel)
Nut	1/4" x 20	ASTM F593 (stainless steel)

Figure 20. Device specifications for Mounting holes

WIRING GENERAL

- All wiring should be done in accordance with applicable electrical codes.
- Wiring methods should be in accordance with the NEC in USA or CEC in Canada.
- All wiring should be done by a qualified, licensed professional.
- Wiring should be protected to help ensure personal safety and to prevent its damage.
- Please connect each cable after confirming the polarity of it is correct.
- Connectors between modules must be inserted until they click.
- When connecting the connectors, please make sure that foreign matter such as water, sand and so on do not get inside the connector. Also, please keep in mind that if you leave the connector in a nonconnected state for a long period of time, contamination of foreign matter is likely to occur.
- If an extreme load is applied to the cable, the cables may come off the junction box body or the connectors.
- Please connect so that a strong load is not applied to the cable.
- Do not disconnect terminals while modules generate electricity and connect electrical load to avoid the hazard of electrical shock.
- Cable conduits should be used in locations where the wiring is inaccessible to children or small animals.
- Please contact your Panasonic Authorized Representative with questions regarding other electrical connections if needed.

MODULE WIRING

- All modules connected in series should be of the same model number and/or type.
- The maximum number of modules in a string can be calculated by dividing the maximum system voltage of the module by its VOC accounting for the lowest ambient temperature at site, e.g.: for a 1000V system, if the lowest ambient temperature is 15°C, the module has a VOC of 44.3 V and a temperature coefficient of VOC of -0.24%/°C, the maximum modules per string is 22 ($\Delta T^{\circ}\text{C} = 25^{\circ} - 15^{\circ} = 10^{\circ}$; $10^{\circ} \times 0.24 = 2.4\%$; $44.3 + 2.4\% = 45.4$; $1000 \text{ V} / 45.4 = 22.0$, so a total of 22 modules or 976 V).
- Qualified system designers can make exact calculations that account for specific project requirements and site conditions.
- If modules will be used in an “offgrid” system, a compatible MPPT (Maximum Power Point Tracking) charge controller is required. Especially charge battery can not be used without MPPT.
- These modules contain factory installed bypass diodes. If these modules are incorrectly connected to each other, the bypass diodes, cable, or junction box may be damaged.
- Do not connect modules in parallel without using connection devices that connect to appropriate FUSE for each series string or each module.

ARRAY WIRING

- The term “array” is used to describe the assembly of several modules on a support structure with associated wiring.
- When installing a PV array, the system design must be completed with reference to the module electrical specifications for proper selection of inverters, fuses, breakers, charging controllers, batteries and other storage devices. In particular, as the temperature characteristic of the PV module, the voltage value rises on the low temperature side. Consider the lowest temperature in the area where the system is installed and select the equipment so that it does not exceed the rated voltage of the equipment.
- Use copper wire which is insulated to withstand the maximum possible system open circuit voltage. For applications where wire conduits are used, follow the applicable codes for outdoor installation of wires in conduits. Minimum diameter of wire conduit is 4 mm². The temperature rating of conductor is -40°F(-40°C) to 194°F(90°C).
- In order to avoid submerging cables and connectors in the water, cables must be fixed either to the module frame using cable fixing holes or to the mounting structure. Also, if the cable is not secured, a force may be applied to the cable from the outside, and the module may be damaged.
- Do not insert PV cable between back side and mounting structure rail. When snow weight is applied to the module, load may be applied to the cable.
- Verify that all fittings are properly installed to protect cables against damage and prevent moisture intrusion.
- Check your local codes for requirements

DRAINAGE HOLES

- In each corner of the EverVolt module frame small drainage holes are spaced 2.2 in (55 mm) from the corner on long and short sides (Figure 22). These allow humidity caused by rain, condensation, snow melt, cleaning or any other process to exit the frame easily and minimize damage.
- These holes must not be used for mounting the module, and they must not be covered by any part of the mounting structure. To enable effective drainage and ensure there is no damage to the module, the drainage holes must remain fully open and enable water egress during and after installation.
- The shape and dimensions of the drainage holes may vary depending on product and/or frame design.

EARTH GROUND WIRING

- A module with exposed conductive parts is considered to be in compliance with UL 61730 only when it is electrically grounded in accordance with the instructions presented below and the requirements of the National Electrical Code.
- When grounding a module, it must be done using an electrical

connection from the module frame. Local regulations may require grounding of the modules.

- EverVolt modules have a small round grounding hole positioned near each corner of the module on both the long side and the short side, as shown in Figure 22 and can be further identified by the grounding symbol stamped in the frame next to it.
- Check all applicable requirements before beginning installation:

- Suitable grounding lugs must be used: Listed (KDER) ILSCO, GBL-4DBT (tin plated) [E34440]

- Grounding cable size should be between 4 - 14 AWG (2.1 mm² - 21.2 mm²)

- Attach grounds to the grounding holes in the module frames,

- Fix lug to the frame using a star washer and lock nut, ensuring a conductive connection

- Follow the grounding device manufacturer's installation instructions to ensure a safe and conductive connection, including any supplementary hardware, e.g., star washer, and tighten according to recommended torque.

- **Length of bolt should be carefully selected** in order to avoid contacting the back-sheet of the module.
- Great care should be exercised to ensure that corrosion caused by the grounding means be avoided.
- Corrosion can increase the resistance of the grounding connection on the module, or can even cause the grounding connection to fail entirely. Corrosion can be caused by the effects of weather, humidity, dirt and so on. It can also be caused when two dissimilar metals are in contact (galvanic reaction).
- To avoid galvanic corrosion, galvanized or hot dipped zinc plated fasteners are preferred, however stainless steel fastening materials are equally suitable.
- We recommend installing a lightning rod and SPD (Surge protection device) to reduce damage or breakdown to the PV module caused by lightning.
- The support bars across the rear of EverVolt modules are connected to the frame via specially designed grounding clips and do not need to be individually grounded.
- Negative grounding of the modules is not required for EverVolt module.

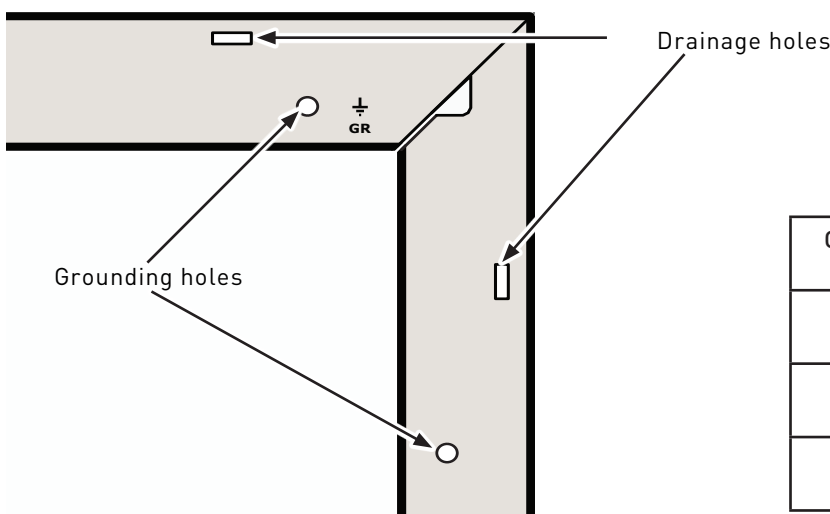

Figure 22. Drainage and grounding holes

Cross section [AWG]	Type	Torque [ft-lb]
4-6	Stranded	2.9
8	Stranded	2.1
10-14	Stranded/Solid	2.3

Figure 23. Grounding lug dimensions and fastening torque

MAINTENANCE

- In order to maintain the optimum output of the module, quality and safety, please conduct periodic inspection or cleaning.
- The need for cleaning will vary dependent on location, rainfall, pollution levels and the angle of installation – the lower the angle of installation, the more cleaning will be required.
- Module cleaning must always be carried out when the modules are cool, e.g., early morning, to avoid breakage through thermal shock.
- Use of high pressure hoses or cleaners is not permitted as these may damage the modules, laminate or cells.
- Avoid putting pressure on the module surface when cleaning or drying, e.g., leaning, standing or resting buckets on it.
- Use only deionized water free from grit and physical contaminants, at ambient temperature and use a sponge, microfiber cloth or a soft brush to wipe away the dirt (rainwater, tap water or diluted alcohol may also be used as a secondary solution).
- For further cleaning a mild, biological and biodegradable washing-up liquid may be used.
- If stains require more effort to be removed, Isopropyl alcohol of a concentration less than 10% may be used.
- Using a soft rubber squeegee, wipe the module surface from the top downwards to remove any residual water from the module glass.
- Take care not to scratch the surface or introduce foreign elements that may cause damage to the module.
- Always rinse the module with plenty of water. Modules can be left to dry in the air or wiped dry with a clean and soft cloth or chamois.
- When cleaning with washing-up liquid, it is recommended to start with smallest area and from the edge of solar modules in order to check no damage occurs to the glass.

- Never use abrasive detergent, strong alkaline detergent, strong acid detergent or a detergent which forms a protective layer on the surface of the glass to clean any part of the module. The performance of a solar modules may be reduced. Please be very careful since the warranty will not cover the damages caused by detergents.
- When cleaning the PV module, please do not put detergent on junction box or connector. If detergents and chemical substances adhere, junction box and connector may be deteriorated or damaged.

SYSTEM INSPECTION

- The system should be inspected regularly to ensure that:
 - Fasteners are secure, tight and free from corrosion
 - Electrical connections are secure, tight, clean and free of corrosion
 - The mechanical integrity of the cables is intact
 - Bonding points to ground are tight, secure and free from corrosion (which could break the continuity between the modules and ground).
- If you need inspection or maintenance, it is recommended to have a licensed authorized professional carry out the inspection or maintenance to avoid the hazards of electric shock or injury.

RECYCLING

Panasonic makes every effort to ensure module packaging is kept to a minimum. The paper and cardboard packaging can be recycled and the protective wrapping and module separating blocks are also recyclable in many areas. Recycle packaging and modules according to local guidelines and regulations.

DISPOSAL OF OLD ELECTRICAL AND ELECTRONIC EQUIPMENT

Modules should be recycled at the end of their useful life according to local guidelines and regulations. By ensuring EverVolt modules are disposed of correctly, you will help prevent potential negative consequences for the environment and human health which could otherwise be caused by inappropriate waste treatment. The majority of the module components can be recycled.

DISCLAIMER OF LIABILITY

Panasonic does not assume responsibility and expressly disclaims liability for loss, damage, or expense arising out of, or in any way connected with installation, operation, use, or maintenance by using this manual.

Panasonic assumes no responsibility for any infringement of patents or other rights of third parties, which may result from use of modules.

No license is granted by implication or under any patent or patent rights. The information in this manual is believed to be reliable, but does not constitute an expressed and/or implied warranty.

As part of our policy of continuous improvement Panasonic reserves the right to make changes to the product, specifications, or manual at any time without prior notice.

The return of any modules will not be accepted by Panasonic unless prior written authorization has been given by Panasonic.

CONTACT INFORMATION

Panasonic Life Solutions Company of America, Two Riverfront Plaza, Newark, NJ 07102

panasonicHIT@us.panasonic.com

na.panasonic.com/us/solar

REVISION HISTORY

Edition	Revision Date	Revised Item	Revised Content
A	10.13.2020	NEW	
B	12.1.2021	Addition of EVPVxxxH and EVPVxxxPK Series	
C	11.15.2022	Addition of EVPVxxxHK Series	

ANNEX 1: INSTALLATIONS USING MODULE LEVEL POWER ELECTRONICS

This section is applicable to EverVolt modules referred to in this installation manual.

Module Level Power Electronics (MLPE) is the name given to the range of module-level components that can be installed in PV system circuits installed on or in buildings to reduce shock hazard for emergency responders.

From January 2019, Section 690.12 of the National Electrical Code (NEC) (in the U.S.A.) requires the module-level rapid shutdown of solar systems (replacing the previous arraylevel shutdown requirement of NEC 2014). This means that all conductors within an array's in (300 mm) boundary have to be reduced to 80 V or less within 30 seconds of rapid shutdown initiation.

MLPE devices may be used on EverVolt modules where desirable or mandatory (note that the certification testing of solar modules does not include testing with MLPE devices).

When installing an MLPE device on an EverVolt module, follow the instructions provided by the device

manufacturer and the instructions specific for EverVolt modules given below. Failure to follow the manufacturer and the EverVolt instructions may invalidate the warranty.

INSTALLATION

-MLPE devices are suitable for use wherever solar modules are suitable for installation. Observe any limitations set by the MLPE manufacturer. (e.g., minimum mounting gap between MLPE and rooftop).

-When attaching an MLPE device to a solar module, it must be secured to the module frame. Follow MLPE manufacturer instructions to ensure optimum mounting of MLPE device and prevent any slippage during operation.

-MLPE devices may also be attached to the mounting construction. In such cases, refer to the instructions provided by the manufacturer.

-Wherever possible, the installation of the MLPE device should not cover the product label on the rear of the module.

-MLPE devices may only be installed on EverVolt modules in the areas shown

in the diagram below (Figure 24):



- To avoid damage to the module and to allow for thermal expansion, there must be a minimum gap of 0.1 in (2.5 mm) between the MLPE device and the module backsheet.
- The mounting holes in the module frame must not be used for the installation of MLPE devices.
- The drilling of extra holes in the frame is not permitted and will invalidate the module warranty.

CONNECTION

- First ensure the installation of the MLPE device is secure and safe.
- Following the device manufacturer's instructions to connect the cables from the MLPE device to the solar module correctly (usually positive to positive [+ to +] and negative to negative [- to -]).
- Connection to the next module in the array should be done from the 'free' cables.

SAFETY

- Immediately disconnect the device if there is a problem during installation.

-  Installation of MLPE device in the green zone is permitted.
-  Installation of MLPE device in the red zone is not permitted.

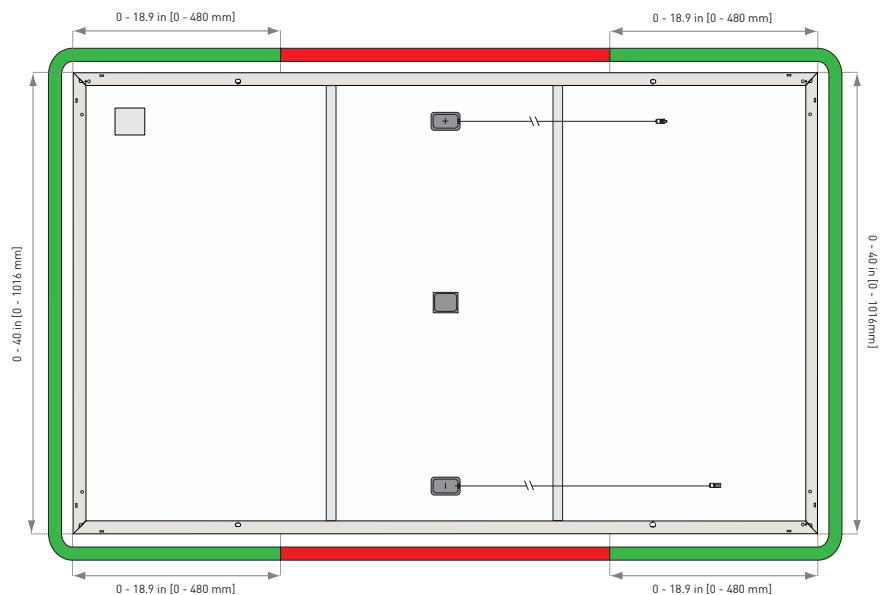

Figure 24. MLPE device installation zones

EverVolt[®]

Panasonic

Panasonic Life Solutions Company of America
Two Riverfront Plaza, Newark, NJ 07102
panasonicsolar@us.panasonic.com
na.panasonic.com/us/solar

All Rights Reserved © 2022 COPYRIGHT Panasonic Corporation
Specifications are subject to change without notice

RS22026BR0-R5