



Description Interruttore non automatico scatolato
 Code MSXM 1600
 No. of poles 4P
 Rated current 1600 A
 Release -

ELECTRICAL CHARACTERISTICS

Standard	IEC/EN 60947-2
Use category	AC-23A, DC-22A
Rated frequency (Hz)	50 / 60
Rated operating voltage (Ue)	690 Vac - 250 Vdc
Rated impulse withstand voltage (Uimp)	8 kV
Overvoltage category	IV
Insulation voltage (Ui)	800 V
Thermal regulation	-
Magnetic regulation	-
Neutral protection	-
Total power loss	225.28 W
Rated short-circuit current making capacity (Icm)	45
Rated short-time withstand current for 0,3s (Icw)	20 kA
I _{dn} regulation	-
DT regulation	-

SERVICE BREAKING CAPACITY (ICU)

220/240Vac
400/415Vac
440Vac
525Vac
690Vac
250Vdc

MECHANICAL CHARACTERISTICS

Execution	Fixed
DIN rail mounting	No
Can be equipped with motor operator	Yes
Compatible interlock	-
Terminals supplied	Rear RC
Assembly position	Any
Upline/downline power supply	Yes
Electrical life (415Vac)	2.000 cycles
Mechanical life	5.000 cycles
Operating temperature	-5°C +65°C
Stocking temperature	-20° +65°
Weight (kg)	32.9
Width	280 mm
Height	370 mm
Depth	140 mm

RATED BREAKING CAPACITY (ICS)

220/240Vac	-
400/415Vac	-
440Vac	-
525Vac	-
690Vac	-
250Vdc	-

DIMENSIONAL

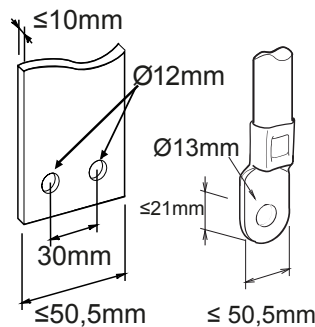



Product Data Sheet

GWD9458

MSX

STANDARDS/APPROVALS

