

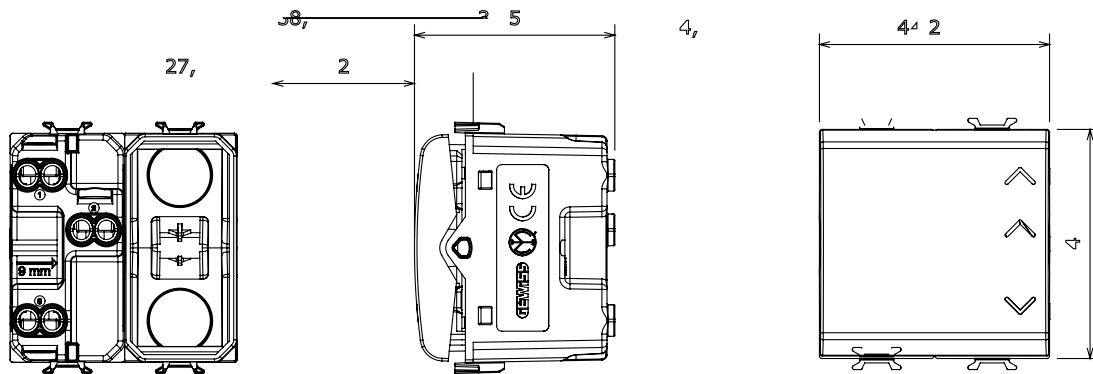

Wide range of control devices, sockets for power supply (conforming to national and international standards) signal pick-up, climate control, comfort management, technical alarm signalling and emergency lighting management. The ChoruSmart modular devices are available in five colours, glossy white, satin white, natural beige, satin black and lacquered titanium and in various sizes from 1/2, 1, 2 and 3 modules. Thanks to the mounting supports for rectangular, square and round boxes, endless combinations can be created with the ChoruSmart range of plates.

Category	Three-way switch	Colour	Satin black
Description	1P - 10AX	Voltage	250 V ac
Standard	EN 60669-1	Resistance at test voltage	2000 V at 50 Hz for 1 minute
Rated power of 230V LED lamps	100 W	Insulation resistance	> 5 MOhm
Wiring terminals	With screw	Prolonged operation switch (no.of position changes)	40.000 at In 250 V ac cosφ=0,6
Thermo-pressure with ball	125 °C	Glow Wire Test	850 °C
Terminal grip on cable traction	> 50 N	Terminal tightening capacity stranded cables (mm ²)	min. 0,75 - max. 2x4
Terminal tightening capacity solid cables (mm ²)	min. 0,5 - max. 2x2,5	No. modules	2
Button key	Neutral	Symbol	UP - DOWN
Material	Technopolymer	Electrocod	0130

DIMENSIONAL



TECHNICAL SYMBOLOGY



STANDARDS/APPROVALS

