

The System modular devices make it possible to create infinite combination between devices and plates, thanks to a complete range that is able to satisfy all design, functional and installation requirements. Colour and finiture: glossy white, bright and versatile
Ideal for flush-mounting solutions (for rectangular or square boxes), surface-mounting solutions, and for special applications. The range includes commands, socket- outlets, protection, indicators, connectors and devices for the control, safety and comfort of your home.

Category	Power	Description	2P+E - 10A
Colour	White	Voltage	250 V ac
Earth pit	-	Standard	Australian
Characteristics	-	For plug pins	Flat
Wiring terminals	With screw	Standard	IEC 60884-1; AS/NZS 3112
Resistance at test voltage	2000 V at 50 Hz for 1 minute	Prolonged operation switch (no.of position changes)	10.000 at In 250 V ac cosφ=0,8
Thermo-pressure with ball	125 °C	Glow Wire Test	850 °C
Terminal grip on cable traction	> 50 N	Terminal tightening capacity stranded cables (mm ²)	min. 1,5 - max. 2x4
Terminal tightening capacity solid cables (mm ²)	min. 1,5 - max. 2x2,5	No. SYSTEM modules	2
Material	Technopolymer	Electrocod	0131

DIMENSIONAL

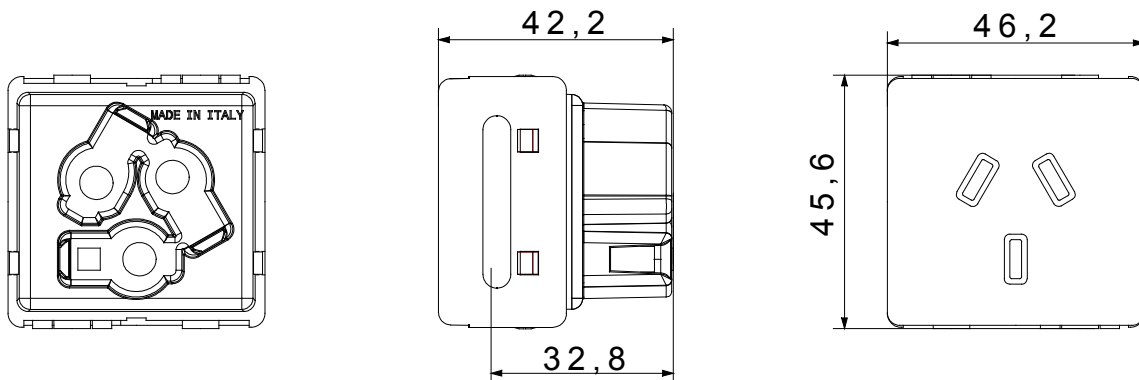

TECHNICAL SYMBOLOGY



STANDARDS/APPROVALS

