

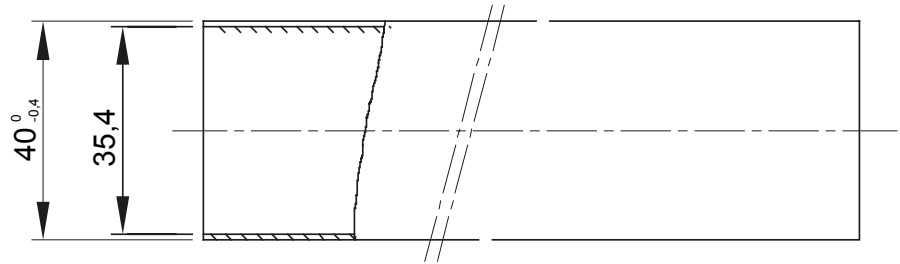

The system of medium rigid protective conduits made of high quality PVC to offer superior performance. Available in diameters from 16 to 32 mm and in lengths from 2 to 3 m. They can be integrated with flexible conduits and junction boxes. Completing the offer, a wide range of couplings and routing components with IP40 and IP67 degree of protection.

Colour	Grey RAL 7035	Material	PVC
Length (m)	3	Conduits Ø (mm)	40
Glow Wire Test	960 °C	Resistance to compression	3 (Medium - 750 N)
Resistance to impact	3 (Medium - 2 J)	Resistance to bending	1 (Rigid)
Electrical characteristics	2 (With electrical insulating characteristics)	Protection against ingress of solid objects without accessories	0
Protection against ingress of water objects without accessories	0	Resistance against corrosion	Not applicable to plastic conduit systems
Fire resistance	1 (Non-flame propagating)	Insulation resistance	100 MΩ a 500V for 1 minute
Protection against ingress of solid objects with accessories	4/6 (It depends on the accessories used)	Protection against ingress of water with accessories	0/5/7 (It depends on the accessories used)
Dielectric rigidity	2000 V a 50 Hz for 15 minutes	Standard	EN 61386-1 EN 61386-21
Family	IRL/B	Classification	33211
Conduit type	Sleeved		

DIMENSIONAL

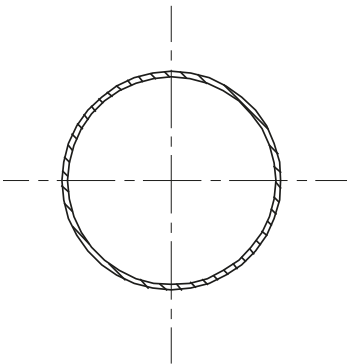

TECHNICAL SYMBOLOGY



STANDARDS/APPROVALS

