

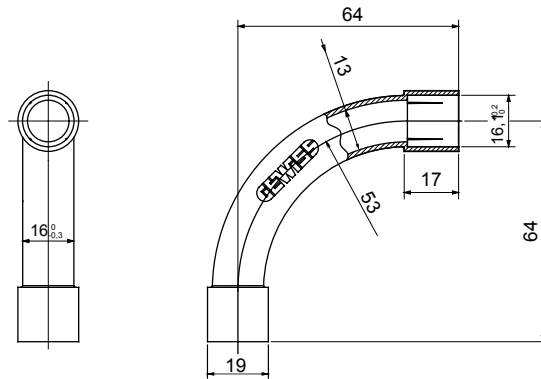

Routing components for rigid protective conduits with IP40 and IP67 protection degree.

|                 |               |                  |  |
|-----------------|---------------|------------------|--|
| Colour          | Grey RAL 7035 | IP degree        | IP40                                     |
| Conduits Ø (mm) | 16            | Type of material | Halogen free in compliance with EN 50642 |
| Electrocod      | 21221         |                  |  |

### DIMENSIONAL



### TECHNICAL SYMBOLOGY

**IP**

**HF**  
HALOGEN FREE

IP40

### STANDARDS/APPROVALS

