

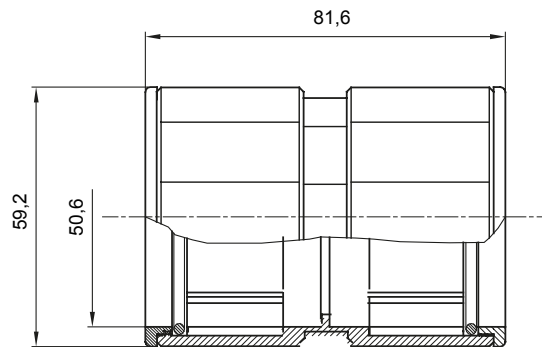

Routing components for rigid protective conduits with IP40 and IP67 protection degree.

Colour	Grey RAL 7035	IP degree	IP67
Conduits Ø (mm)	50	Type of material	Halogen free in compliance with EN 50642
Electrocod	21221		

### DIMENSIONAL

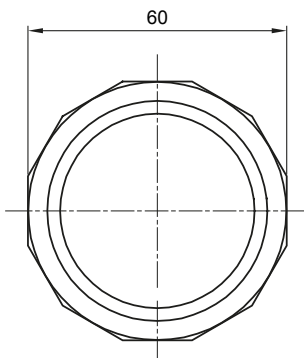

### TECHNICAL SYMBOLOGY

**IP**

**HF**  
HALOGEN FREE

IP67

### STANDARDS/APPROVALS

