



Range of Watertight surface-mounting boards made in thermoplastic material GW PLAST 120. In compliance with IEC 61439-1 (CEI 17/113), IEC 61439-2 (CEI 17/114), IEC 60670-1 (CEI 23/48) e IEC 60670-24 (CEI 23/49). Available in 4 sizes, transparent and black door versions with IP55 protection degree. Accessories available: panels with window complete with extrable frames, for modular devices and moulded-case circuit breakers up to 160A. Indicated for automation and distribution.

Insulation class		II	Colour	Grey RAL 7035
Outer dim. LxHxD (mm)		316x396x160	IP degree	IP55
Material	Technopolymer GWPLAST 120		Mechanical resistance	IK08
No. locks		2	No. of modules EN 50022	24 (12X2)
Dispersible power A (W)		42	Dispersible power B (W)	34
Glow Wire Test		650 °C	Operating temperature	-25 +60 °C
Insulation voltage (Ui)		750 V	Type of material	Halogen-free in compliance with EN 60754-2
Electrocod		1312	Thermo-pressure with ball	110 °C
Accessories for insulation restoring	GW44621-GW46446-GW46451		Standard	EN 61439-1, EN 61439-2, EN60670-1, IEC 60670-24
Family		44 CEP	Maximum rated insulation voltage (Ui)	750 V
Type of door			Transparent door	

BEHAVIOUR WITH CHEMICAL AND ATMOSPHERIC AGENTS

Saline solution	Acids		Bases		Solvents				Mineral oil	UV rays
	Concentrated	Diluted	Concentrated	Diluted	Hexane	Benzol	Acetone	Ethyl alcohol		
Resistant	Limited resistance	Limited resistance	Limited resistance	Limited resistance	Limited resistance	Not resistant	Not resistant	Limited resistance	Limited resistance	Limited resistance

DIMENSIONAL

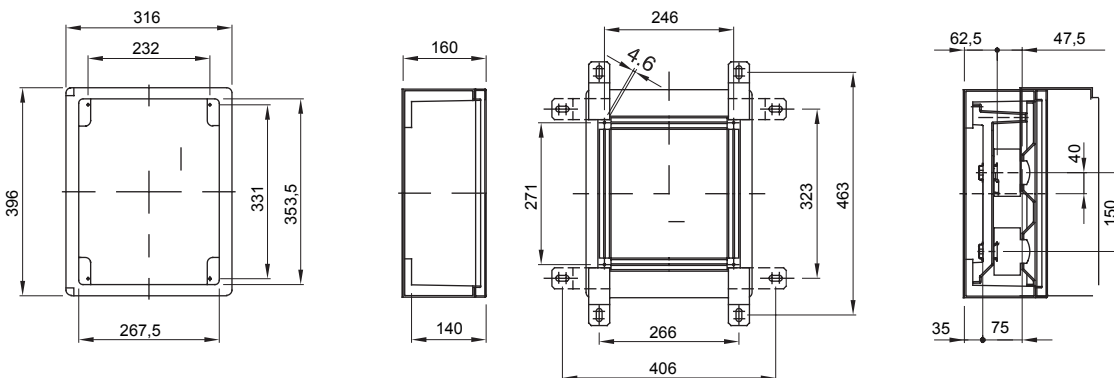

TECHNICAL SYMBOLOGY



II

IP

IP55

IK

IK08

GWT

650 °C

INSTALLATION



-25 +60 °C

HF

HALOGEN FREE

Halogen-free in compliance with EN 60754-2



110 °C

STANDARDS/APPROVALS

