

Industrial Diesel Generator - BAUDOUIIN 450kVA/360kW - 110/230/400V(50/60Hz)



General Specifications

Standby Power (kVA)	450
Standby Power (kW)	360
Prime Power (kVA)	410
Prime Power (kW)	327
Frequency (Hz)	50 / 60
Cooling System	Water Cooling

- 1) Standby power: The max power available during a variable electrical power sequence, under the stated operating conditions, for which a generating set is capable of delivering in the event of a utility power outage. Overloading isn't permissible.
- 2) Prime Power: The maximum power which a generating set is capable of delivering continuously whilst supplying a variable electrical load. Average load should be 70%. The generator can be overloaded 10% for 1 hour per 12 hrs.

Dimensions & Weight

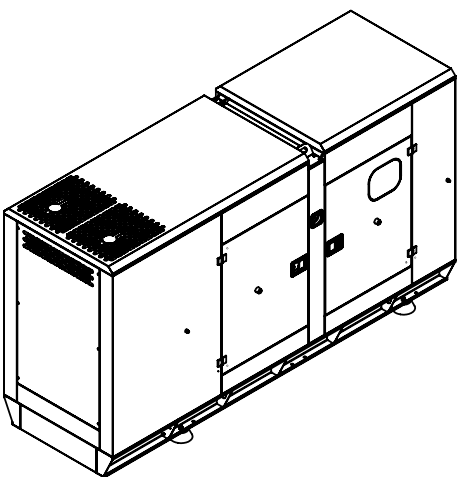

Type	Length (mm)	Width (mm)	Height (mm)	Weight (Kg)	Fuel Tank Capacity
With canopy	4000	1500	2200	3080	630
Open type	3300	1500	2500	3155	630

Engine Specifications

Engine	BAUDOIN	
Engine Model	6M21G440/5	
Number of Cylinders	6 Inline	
Injection System	Direct	
Compression Ratio	17 : 1	
Bore (mm)	126	
Stroke (mm)	165	
Displacement (lt)	12.54	
Air Intake	Turbină	
Speed (RPM)	1500	
Oil Capacity (lt)	30	
Standby Power (kW / hp)	450 / 542	
Prime Power (kW / hp)	368 / 493	
Fuel Type	Euro Diesel	
Governor System	Electronic	
Cooling System	Water Cooling	
Coolant Capacity (lt)	47	
Fuel Consumption (lt / h)	Full Load	85.5
	75% Load	63.5
	50% Load	43.2

Alternator Specifications

Frequency (Hz)	50 / 60	
Power (kVA)	450	
Voltage (V)	110 / 230 / 400	
No. of Phases	3	
Voltage Regulation	±1%	
Insulation Class	H	
Protection Standard	IP23	
Power Factor (Cos)	0.8	

Technical Specifications

ENGINE

- BAUDOUIN heavy duty diesel engine
- 12V starter and charge alternator
- Replaceable air, fuel and oil filters
- Mechanical governor control
- Tropical type radiator
- Flexible fuel hose
- Oil drain valve and extension hose
- Industrial type silencer and steel compensator
- Maintenance-free starter battery
- Water jacket heater
- 1500 rpm engine speed

ALTERNATOR

- IP 23 Protection Standard
- H Insulation Class
- 50/60 Hz Frequency
- 4 pole brushless synchronous type alternator
- Automatic Voltage Regulator (AVR)
- 110/230/400V AC Output Voltage - 1500 rpm

SOUND PROOF CANOPY AND CHASSIS

- Convenient design for easy lifting and carrying
- High standard sound proof canopy design
- Modular design with easily removable nuts - bolts
- Lockable doors
- Transparent window for watching Control Panel
- Electrostatic powder painted, providing protection against harsh weather conditions
- Emergency STOP button
- Fuel tank inside the chassis
- Anti-vibration wedges (engine - chassis and chassis - ground)

OPTIONAL

- Thermal magnetic CB (for automatic models)
- Super Silent Canopy
- Mobile Generator Sets
- Automatic fuel filling system
- Synchronization panel
- 3 Pole and 4 Pole ATS (Automatic Transfer Switch)
- Fuel Heater, Oil Heater
- External fuel tank and automatic fuel filling system
- Fuel - water separator filter
- Remote monitoring and control system



Control Panel

Web based Next Generation Controller



SPECIFICATIONS

- Diesel and gas genset support
- 400Hz operation support
- 400 event logs, full snapshot
- All parameters front panel editable
- 3 level configuration password
- 128x64 graphical LCD display
- Downloadable languages
- Waveform display of V & I
- Harmonic analysis of V & I
- 16Amp MCB & GCB outputs
- 8 configurable digital inputs
- 6 configurable digital outputs
- 3 configurable analog inputs
- Both CANBUS-J1939 & MPU
- 3 configurable service alarms
- Multiple automatic exerciser
- Weekly operation schedule
- Dual mutual standby with equal aging of gensets
- Manual "speed fine adjust" on selected ECUs
- Automatic fuel pump control
- Disable protections feature
- Excess power protection
- Reverse power protection
- Overload IDMT protection
- Load shedding, dummy load
- Multiple load management
- Current unbalance protection
- Voltage unbalance protection
- Fuel filling & fuel theft alarms
- Battery back-up real time clock
- Idle speed control
- Battery charge run enabled
- Combat mode support
- Multiple nominal conditions
- Contactor & MCB drive
- 4 quadrant genset power counters
- Mains power counters
- Fuel filling counter
- Fuel consumption counter
- Modem diagnostics display
- Configurable through USB, RS-232 and GPRS
- Free configuration program
- Allows SMS controls
- Ready for central monitoring
- Mobile genset support
- Automatic GSM geo-location
- GPS connectivity (RS232)
- Easy USB firmware upgrade
- IP65 rating with optional gasket

MEASUREMENTS

- Mains & genset PN/PP voltages
- Mains & genset frequency
- Mains & genset phase currents
- Mains & genset neutral currents
- Mains & genset, phase & total, kW, kVA, kVA_r, pf
- Engine speed
- Battery voltage

FUNCTIONALITIES

- AMF unit
- ATS unit
- Remote start controller
- Manual start controller
- Engine controller
- Remote display panel

COMMUNICATION

- USB Device
- RS-232 (2400-57600baud)
- J1939-CANBUS
- Geo-locating through GSM
- GPS support (RS-232)
- Internet Central Monitoring
- SMS message sending
- E-mail sending
- Free PC software: Rainbow Plus
- Modbus RTU
- Modbus TCP/IP