

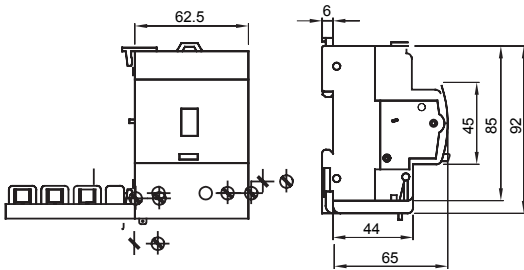

Description	RESIDUAL CURRENT DEVICE
Code	BD
No. of poles	4P
No. modules	3.5
Rated current	63 A
Rated residual operating current	300 mA
Type	A[S]
Rated voltage (IEC/EN 61009-1 app. G, IEC/EN 61009-2-1 app. G)	400 V

Standard	IEC/EN 61009-1 app. G, IEC/EN 61009-2-1 app. G	Rated frequency (Hz)	50/60 Hz
Insulation voltage (Ui)	500 V	Rated impulse withstand voltage (Uimp)	4 kV
Overvoltage category	III	Level of immunity (8/20 μs)	3000 A
Section rigid cable	Max 35 mm ²	Section flexible cable	Max 35 mm ²
Operating temperature	-25 +40 °C	Stocking temperature	-40°C + +70°C
Rated tightening torque	2 Nm	Assembly position	Any

DIMENSIONAL



WIRING DIAGRAM

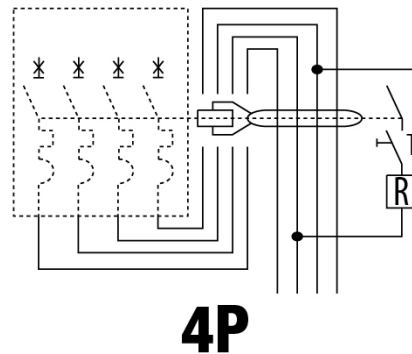

STANDARDS/APPROVALS

