

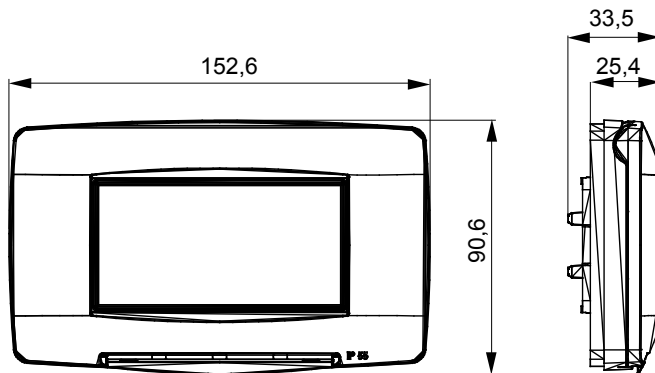

Range of ChoruSmart domestic series plates, made in a wide variety of shapes, colours, materials and finishes. It includes five different shapes (ONE, GEO, EGO, LUX, ICE and ICE Touch) for rectangular boxes with a capacity of up to 12 modules and three different shapes (ONE International, GEO International and LUX International) suitable for round/square boxes, both single and combined in horizontal or vertical configurations, with a capacity of 2 up to 2+2+2+2 modules. All ChoruSmart domestic series plates use the same supports, without the need for additional adapters. The range also includes blank plates, watertight IP55 plates and contour plates.

Description	4 modules	Colour	Glossy black
Material	Technopolymer	Finishing	Glossy
IP degree	IP55	For box	Rectangular
Included support	GW16804	Glow wire test	650 °C
Thermo-pressure with ball	70 °C	Standard	EN 60669-1
Electrocod	0110		

### DIMENSIONAL



### TECHNICAL SYMBOLOGY

**IP**

IP55

**GWT**

650 °C



70 °C

### STANDARDS/APPROVALS

