

CHORU **S** MART

**GEWISS**

CONNECTED SMART HOME

**SYSTEM MANUAL**



# CONTENTS

<b>1. INTRODUCTION</b>	<b>5</b>
<b>2. THE RANGE</b>	<b>6</b>
<b>3. SYSTEM SPECIFICATIONS AND ARCHITECTURE</b>	<b>19</b>
<b>4. CONFIGURATION</b>	<b>21</b>
4.1 "TRADITIONAL SYSTEM" FUNCTIONS WHICH CAN BE CONTROLLED BEFORE PERFORMING CONFIGURATION WITH THE APP	21
<b>5. FUNCTIONS</b>	<b>23</b>
5.1 BASE FUNCTIONS	23
5.1.1 CONTROL OF LIGHTS AND ROLLER SHUTTERS	23
5.1.2 CLIMATE CONTROL	23
5.1.3 SCENES	23
5.1.4 PROGRAMMED SCENES	23
5.1.5 SENSORS AND ALARMS	23
5.2 ADVANCED FUNCTIONS	25
5.2.1 ENERGY MANAGEMENT	25
5.2.2 TIMER THERMOSTAT FUNCTION	26
5.3 CLOUD PLATFORM INTEGRATION	27
<b>6. AUXILIARY INPUTS OF CONNECTED DEVICES</b>	<b>28</b>
6.1 DESCRIPTION	28
6.2 MAXIMUM CONNECTION LENGTH	28
6.3 DESCRIPTION OF FUNCTIONS WHICH CAN BE ASSOCIATED WITH THE AUXILIARY INPUTS	28
6.4 FACTORY CONFIGURATION	29
<b>7. EGO SMART PLATE</b>	<b>30</b>
7.1 POWER SUPPLY	30
7.2 SHIFT FUNCTION OR DUAL FUNCTION	30
7.3 WARNING AND ALARM SIGNALLING	30
<b>8. BATTERY SENSORS</b>	<b>32</b>
<b>9. ECO CONNECTED 4-COMMAND PUSH-BUTTON PANELS MODULE – ZIGBEE</b>	<b>33</b>
<b>10. LEGACY ZIGBEE DEVICES COMPATIBLE WITH CONNECTED SMART HOME</b>	<b>34</b>
<b>11. APP</b>	<b>34</b>
11.1 USER PROFILES AND ACCESS PERMISSIONS	34
11.2 PUSH NOTIFICATIONS – NOTIFICATIONS AND ALARMS	34
<b>12. APPLICATION EXAMPLES – CONNECTION DIAGRAMS</b>	<b>40</b>
12.1 TRANSFORMING AN EXISTING SYSTEM INTO A SMART SYSTEM: CONNECTED AXIAL 2-WAY SWITCH MODULE	40
12.2 LIGHT CIRCUIT CONTROLLED BY FOUR POINTS WITH CENTRALISED OFF COMMAND: CONNECTED AXIAL 2-WAY SWITCH MODULE	41
12.3 TRANSFORMING AN EXISTING SYSTEM INTO A SMART SYSTEM: CONNECTED AXIAL DIMMER MODULE	42
12.4 CONNECTION DIAGRAM: MULTI-POINT LIGHTING COMMAND AND CONTROL	42
12.5 EXIT HOME SCENE COMMAND TO TURN OFF LIGHTS AND CLOSE SHUTTERS/VENETIAN BLINDS: AUXILIARY AXIAL MODULE	43
12.6 TRANSFORMING AN EXISTING SYSTEM INTO A SMART SYSTEM: CONNECTED AXIAL ROLLER SHUTTER MODULE	43
12.7 CONNECTION DIAGRAM FOR CONTROL FROM MULTIPLE POINTS OF ONE ROLLER SHUTTER/VENETIAN BLIND	44
12.8 CENTRALISED CONTROL OF A GROUP OF ROLLER SHUTTERS/VENETIAN BLINDS	44
12.9 CONNECTION DIAGRAM: 2 COMMANDS CONNECTED AXIAL MODULE	45
12.10 CONNECTION DIAGRAM: CONTROLLED SOCKET-OUTLETS	46
12.11 CONNECTION DIAGRAM: CONNECTED ENERGY METER	47
12.12 CONNECTION DIAGRAM: CONNECTED MOTION SENSOR	48
12.13 CONNECTION DIAGRAM: CONNECTED THERMOSTAT	49
12.14 WIRELESS (ZIGBEE) SENSORS: FLOOD ALARM	49
12.15 WIRED SENSORS: GAS ALARM	50
12.16 WIRELESS (ZIGBEE) SENSORS + WIRED SENSORS	50

12.17	OPEN WINDOW NOTIFICATION .....	51
<b>13.</b>	<b>INSTALLATION.....</b>	<b>52</b>
13.1	DISTANCES.....	52
13.2	INSTALLATION NOTES.....	52
<b>14.</b>	<b>FIRMWARE UPDATE .....</b>	<b>53</b>
<b>15.</b>	<b>DIAGNOSIS.....</b>	<b>54</b>
<b>16.</b>	<b>FAQ.....</b>	<b>55</b>

## 1. INTRODUCTION

ChoruSmart allows you to create traditional, Connected Smart Home or Home&Building Pro systems in a complete and scalable manner using the best available technologies, completing them with the wide range of formats, colours and finishes of the devices and plates offered by GEWISS.



### Traditional system

The ChoruSmart offering for traditional systems is composed of wired technological and aesthetic solutions, both simple and advanced, for any building type. It offers innovative control points such as the EVO axial versions and touch versions, allowing you to centralise lights and roller shutters with ease, as well as traditional tilting and soft click commands. The range also includes Italian and international socket-outlets, technical alarms, signal take-off, protection, personal security and domestic comfort management devices.

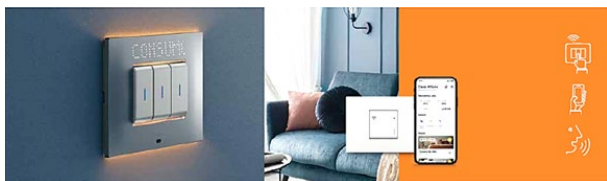

### Connected Smart Home

ChoruSmart also allows for a variety of connected devices, giving rise to a range of intelligent, convenient and wireless solutions. EGO SMART plates, the distinctive elements of the entire ecosystem, offer a unique and customisable interface with which to control domestic consumption, security and comfort with ease and simplicity.

The Zigbee wireless protocol allows for integration with the most important smart speakers on the market with Google Home, Amazon Alexa and IFTTT IoT platforms, thanks to the Home Gateway App, allowing you to manage lights, roller shutters and scenes by voice, as well as checking on your consumption or receiving notifications of issues. The wireless controls, which do not require batteries, also allow you to add other control points at any time with complete freedom.

The ChoruSmart *Connected Smart Home* offering is the perfect solution for residential and small businesses, both for new buildings and for the renovation and revamping of existing systems with minimal structural interventions.







### Home & Building Pro

If the ChoruSmart range is completed with BUS wiring using the international standard protocol KNX, it is possible to create an advanced, expanded system. You will have an intelligent and customisable system at your disposal, complete with all functions, which is able to integrate with third-party systems and devices – video entryphones, smart locks, entertainment – controllable via apps, voice assistants or touchscreen panels. The *Home & Building Pro* system is suitable for advanced automation of residential solutions and small or medium-sized business, and guarantees security, well-being, efficiency and sustainability.

This system manual describes the **Connected Smart Home** solution.







## 2. THE RANGE

The main technical characteristics of the new ChoruSmart connected devices are described in this chapter. For pre-existing Zigbee devices, refer to the website.





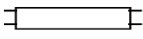

HOME GATEWAY				
<i>Code:</i>	GW10840, GW12840, GW13840, GW14840, GW15840			
<i>Description:</i>	Home Gateway is flush-mounting multi-protocol device with Zigbee, WiFi and Bluetooth (BLE) interfaces. It takes up only two modules and allows for configuring, supervising, commanding and controlling the Smart Home system via the Cloud. This management is performed via a dedicated application (Home Gateway App).			
<i>Functions:</i>	<ul style="list-style-type: none"> <li>Connection, configuration and management of the Smart Home system via the app and the Gewiss cloud services</li> <li>Coordinator of the Zigbee network</li> </ul>			
<i>Link to documentation on website:</i>				
<a href="#">GW10840</a>	<a href="#">GW12840</a>	<a href="#">GW13840</a>	<a href="#">GW14840</a>	<a href="#">GW15840</a>
				
Glossy White	Satin Black	Natural satin beige	Titanium	Satin White
TECHNICAL SPECIFICATIONS				
<i>Power supply:</i>	100 ÷ 240V AC, 50/60 Hz			
<i>Max. dispersible power:</i>	0.7 W			
<i>Number of modules:</i>	2			
<i>Requirements:</i>	Requires a 2.4 GHz Internet (WiFi) connection			
<i>Safety requirements for installation:</i>	Install 315mA 250V ac fuse on the line conductor			

### EGO SMART POWER SUPPLY AND COMMUNICATION PLATE



<i>Code:</i>	GWA1700
<i>Description:</i>	Connected device for either flush-mounting (with the ChoruSmart GW1x750 blanking module) or rear connection, designed to power and manage the EGO SMART plate (GW16003SXX, GW16004SXX, GW16022SXX) near which it must be installed. The EGO SMART plate must be connected to the power supply device by means of the power wire supplied with the plate itself.
<i>Functions:</i>	<ul style="list-style-type: none"> <li>• Power supply to the EGO SMART plate and communication with the rest of the system</li> </ul>
<i>Link to documentation on website:</i>	
<a href="#">GWA1700</a> 	
<b>TECHNICAL SPECIFICATIONS</b>	
<i>Power supply:</i>	100 ÷ 240V AC, 50/60 Hz
<i>Max. dispersible power:</i>	0.9W (100V AC)
	0.7W (240V AC)
<i>Number of modules:</i>	1
<i>Outdoor transmission radius:</i>	100m
<i>Compatible blanking module:</i>	GW1x750
<i>EGO SMART plate power supply pre-arrangement:</i>	Yes

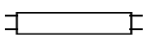

<b>CONNECTED AXIAL TWO-WAY SWITCH MODULE</b>			
<b>Code:</b>	GWA1201, GWA1202		
<b>Description:</b>	Flush-mounting connected device, with front push-button with axial operation for commanding an ON/OFF or Timed ON load via an output contact with potential. The device has two independent relays with a “logical” interlock, allowing it to work as a two-way switch (upstream from a junction) or an actuator (connecting one relay only) to control loads of 100–240V AC, 50/60 Hz. The relays are not managed independently, so it is not possible to connect two different loads to them.		
<b>Functions:</b>	<ul style="list-style-type: none"> <li>• ON/OFF actuation</li> <li>• Timed ON/OFF actuation</li> <li>• Scene</li> <li>• Switching associated with a presence/motion sensor</li> <li>• Switching associated with a binary sensor</li> <li>• Measurement of power and active energy consumed</li> <li>• SHIFT function (dual function)</li> </ul>		
<i>Link to documentation on website:</i>			
<a href="#">GWA1201</a>	<a href="#">GWA1202</a>		
			
1 module	2 modules		
<b>TECHNICAL SPECIFICATIONS</b>			
<b>Auxiliary inputs:</b>	2		
<b>Connection requirements for auxiliary inputs:</b>	Must both be connected to line or neutral. It is not possible to connect one input to the line and the other to the neutral conductor.		
<b>Possible auxiliary input functions:</b>	<ul style="list-style-type: none"> <li>• Control of a local load</li> <li>• Sending of Zigbee commands or statuses: <ul style="list-style-type: none"> <li>➤ ON/OFF/TOGGLE command</li> <li>➤ Timed ON command (stair raiser light)</li> <li>➤ Wired sensor status (binary 0/1)</li> <li>➤ Control of curtains and roller shutters with single or double push-button</li> <li>➤ Dimmer control with single or double push-button</li> <li>➤ Alarm</li> <li>➤ Scene command</li> </ul> </li> </ul>		
<b>Max. cable length (auxiliary inputs):</b>	50m		
<b>Power supply:</b>	100 ÷ 240V AC, 50/60 Hz		
<b>Maximum dissipated power:</b>	2.6 W		
<b>Number of modules:</b>	2		
<b>Outdoor transmission radius:</b>	100m		
<b>Type of load:</b>		4-250W (100V AC) 4-500W (240V AC)	
		4-50W (100V AC) 4-100W (240V AC)	
		4-60W (100V AC) 4-120W (240V AC)	
		4-125VA (100V AC) 4-250VA (240V AC)	
<b>Safety requirements for installation:</b>	Install circuit breaker of max 10A on the line conductor to protect the device		
<b>EGO SMART plate power supply pre-arrangement:</b>	Yes		



CONNECTED AXIAL DIMMER MODULE		
<b>Code:</b>	GWA1221, GWA1222	
<b>Description:</b>	Connected flush-mounting device with two front push-buttons with axial activation, for commanding and regulating incandescent, halogen, LED and fluorescent lamps (240V AC, 4-150W), and for loads driven by electronic transformers (240V AC, 4-150VA). Trailing edge load control mode.	
<b>Functions:</b>	<ul style="list-style-type: none"> <li>• ON/OFF actuation</li> <li>• Relative regulation of the brightness</li> <li>• Absolute brightness regulation</li> <li>• Regulating the load control maximum and minimum</li> <li>• Timed ON/OFF actuation</li> <li>• Scene</li> <li>• Switching associated with a presence/motion sensor</li> <li>• Switching associated with a binary sensor</li> <li>• SHIFT function (dual function)</li> </ul>	
<i>Link to documentation on website:</i>		
<a href="#">GWA1221</a>	<a href="#">GWA1222</a>	
		
1 module	2 modules	
TECHNICAL SPECIFICATIONS		
<b>Auxiliary inputs:</b>	2	
<b>Connection requirements for auxiliary inputs:</b>	Must both be connected to line or neutral. It is not possible to connect one input to the line and the other to the neutral conductor.	
<b>Possible auxiliary input functions:</b>	<ul style="list-style-type: none"> <li>• Control of a local load</li> <li>• Sending of Zigbee commands or statuses: <ul style="list-style-type: none"> <li>➤ ON/OFF/TOGGLE command</li> <li>➤ Timed ON command (stair raiser light)</li> <li>➤ Wired sensor status (binary 0/1)</li> <li>➤ Control of curtains and roller shutters with single or double push-button</li> <li>➤ Dimmer control with single or double push-button</li> <li>➤ Alarm</li> <li>➤ Scene command</li> </ul> </li> </ul>	
<b>Max. cable length (auxiliary inputs):</b>	50m	
<b>Power supply:</b>	100 ÷ 240V AC, 50/60 Hz	
<b>Maximum dissipated power:</b>	5.7 W	
<b>Number of modules:</b>	2	
<b>Outdoor transmission radius:</b>	100m	
<b>Type of load:</b>		4-75W (100V AC)
		4-150W (240V AC)
		4-75W (100V AC)
		4-150W (240V AC)
		4-75W (100V AC)
		4-150W (240V AC)
		4-75VA (100V AC)
		4-150VA (240V AC)
<b>Safety requirements for installation:</b>	Install an F1AH 250V ac fuse on the line conductor	
<b>Installation restriction:</b>	<ul style="list-style-type: none"> <li>• Do not install thermostats or timer thermostats next to the dimmer</li> </ul>	

	<ul style="list-style-type: none"><li>• Max 2 dimmers per two-gang backbox: the loads switchable by each regulator must be downrated by 50%</li><li>• Do not install 2 dimmers side-by-side. Insert a blanking module between the two devices</li></ul>
--	---

<b>CONNECTED AXIAL ROLLER SHUTTER MODULE</b>	
<i>Code:</i>	GWA1231, GWA1232
<i>Description:</i>	Flush-mounting connected device for commanding the motor that drives roller shutters, curtains, Venetian blinds, roller blinds, etc. via 2 interlocked output contacts with potential. The device is fitted with two relays for driving a 100-240V AC, 50/60 Hz motor that controls the up and down movement.
<i>Functions:</i>	<ul style="list-style-type: none"> <li>• Movement: UP/DOWN/STOP</li> <li>• Position %</li> <li>• Slat opening/closure adjustment</li> <li>• Scenes</li> <li>• Weather alarm</li> <li>• Automatic calibration</li> <li>• SHIFT function (dual function)</li> </ul>
<i>Link to documentation on website:</i>	
<a href="#">GWA1231</a>	<a href="#">GWA1232</a>
	
1 module	2 modules
<b>TECHNICAL SPECIFICATIONS</b>	
<i>Auxiliary inputs:</i>	2
<i>Connection requirements for auxiliary inputs:</i>	Must both be connected to line or neutral. It is not possible to connect one input to the line and the other to the neutral conductor.
<i>Possible auxiliary input functions:</i>	<ul style="list-style-type: none"> <li>• Control of a local load</li> <li>• Sending of Zigbee commands or statuses: <ul style="list-style-type: none"> <li>➤ ON/OFF/TOGGLE command</li> <li>➤ Timed ON command (stair raiser light)</li> <li>➤ Wired sensor status (binary 0/1)</li> <li>➤ Control of curtains and roller shutters with single or double push-button</li> <li>➤ Dimmer control with single or double push-button</li> <li>➤ Alarm</li> <li>➤ Scene command</li> </ul> </li> </ul>
<i>Max. cable length (auxiliary inputs):</i>	50m
<i>Power supply:</i>	100 ÷ 240V AC, 50/60 Hz
<i>Maximum dissipated power:</i>	2W
<i>Number of modules:</i>	2
<i>Outdoor transmission radius:</i>	100m
<i>Output contacts:</i>	2.3 A cosφ 0.6 (100V AC)
	2.3 A cosφ 0.6 (240V AC)
<i>Safety requirements for installation:</i>	Install circuit breaker of max 10A on the line conductor to protect the device
	The motor controlling the device must be fitted with a limit switch sensor or an automatic clutch
<i>Limits of compatible weather sensors:</i>	5
<i>EGO SMART plate power supply pre-arrangement:</i>	Yes











CONNECTED AXIAL 2-COMMAND MODULE	
<b>Code:</b>	GWA1241, GWA1242
<b>Description:</b>	<p>Flush-mounting device for sending 2 independent Zigbee commands via the 2 local axial push-buttons. It has 2 inputs (auxiliary axial commands, push-buttons and traditional one-way switches, sensors, etc.) for sending Zigbee commands and statuses.</p> <p>The device can send 2 Zigbee commands (ON/OFF and lamp dimming command, roller shutter command, general loads command, scenes) via the local push-buttons. The inputs can be used to add Zigbee commands to other actuators (ON/OFF and lamp dimming command, roller shutter and Venetian blind command, general loads command, scenes) or the sending of the sensor status on the Zigbee network.</p>
<b>Functions:</b>	<ul style="list-style-type: none"> <li>• Sending of Zigbee commands or statuses <ul style="list-style-type: none"> <li>○ ON/OFF/TOGGLE command</li> <li>○ Timed ON command (stair raiser light)</li> <li>○ Control of curtains and roller shutters with single or double push-button</li> <li>○ Dimmer control with single or double command</li> <li>○ Scene command</li> </ul> </li> <li>• SHIFT function (dual function)</li> </ul>
<i>Link to documentation on website:</i>	
<a href="#">GWA1241</a>	<a href="#">GWA1242</a>
	
1 module	2 modules
TECHNICAL SPECIFICATIONS	
<b>Auxiliary inputs:</b>	2
<b>Connection requirements for auxiliary inputs:</b>	Must both be connected to line or neutral. It is not possible to connect one input to the line and the other to the neutral conductor.
<b>Possible auxiliary input functions:</b>	<ul style="list-style-type: none"> <li>• Sending of Zigbee commands or statuses: <ul style="list-style-type: none"> <li>➤ ON/OFF/TOGGLE command</li> <li>➤ Timed ON command (stair raiser light)</li> <li>➤ Wired sensor status (binary 0/1)</li> <li>➤ Control of curtains and roller shutters with single or double push-button</li> <li>➤ Dimmer control with single or double push-button</li> <li>➤ Alarm</li> <li>➤ Scene command</li> </ul> </li> </ul>
<b>Max. cable length (auxiliary inputs):</b>	50m
<b>Power supply:</b>	100 ÷ 240V AC, 50/60 Hz
<b>Absorbed power:</b>	0.47W (100V AC)
	0.56W (240V AC)
<b>Number of modules:</b>	2
<b>Outdoor transmission radius:</b>	100m
<b>Safety requirements for installation:</b>	Install circuit breaker of max 10A on the line conductor to protect the device
<b>EGO SMART plate power supply pre-arrangement:</b>	Yes

### CONNECTED ENERGY METER WITH LOAD CONTROL





<b>Code:</b>	GWA1918
<b>Description:</b>	Flush-mounting device with load control and power/energy measurement functions (single-phase voltage 100-240V AC 50/60 Hz, max current 70A min 0.05A). The device measures and monitors the electricity consumption (power and energy consumed and produced) in a home or part of a building. In addition to monitoring consumption, it also has a load priority function: it automatically disconnects electrical loads to prevent the incomer fuse or meter from tripping out when the contractually available power supply or fuse rating is exceeded, thereby avoiding problems for the user.
<b>Functions:</b>	<ul style="list-style-type: none"> <li>• Measurement of electric values</li> <li>• Control unit and load disconnection</li> </ul>
<b>Link to documentation on website:</b>	
<a href="#">GWA1918</a> 	

### TECHNICAL SPECIFICATIONS





<b>Power supply:</b>	100 ÷ 240V AC, 50/60 Hz	
<b>Absorbed power:</b>	0.2W (100V AC)	
	0.36W (240V AC)	
<b>Max. current:</b>	85A	
<b>Number of modules:</b>	1	
<b>Outdoor transmission radius:</b>	100m	
<b>The loads must be controlled by Zigbee connected actuators:</b>	GWA1x826	ON/OFF actuator with energy measurement
	GWA1201/2	Connected axial two-way switch module
	GWA1221/2	Connected Axial Roller Shutter Module
	GWA1521	ON/OFF actuator – 1 potential-free channel
	GWA1522	ON/OFF actuator – 2 channels with 230 V potential
	GWA1523	ON/OFF actuator with power measurement - 1 channel with 230V potential
	GWA1526	Zigbee RF smart plug
<b>Safety requirements for installation:</b>	Install F6 13AH 250V ac fuse or install circuit breaker of max 6A on the line conductor to protect the device	
<b>Limit of controllable remote loads:</b>	Max 10	
<b>Installation requirements for the current transformer (CT):</b>	The current transformer must be installed so that the line cable is inserted in the CT on the side marked 'K'.	
	Maximum conductor CSA: 25 mm <sup>2</sup>	
	The current transformer must be connected to the GWA1918 meter, wiring it to terminals S1+ (red cable) and S2- (black cable).	

<b>CONNECTED MOTION SENSOR</b>		
<b>Code:</b>	GW10856, GW12856, GW13856, GW14856, GW15856	
<b>Description:</b>	<p>Motion sensor, flush-mounting, with detection based on the light set threshold value. Fixed lens. Parameters can be set during configuration via app: light threshold value, shut-off time after presence detection.</p> <p>Live local contact for direct control of the load; connectable loads: incandescent and halogen lamps (240V ac): 500W, LED lamps (240V ac): 100W, fluorescent lamps (240V ac): 120W, loads driven by electronic transformers (240V ac): 250VA.</p>	
<b>Functions:</b>	<ul style="list-style-type: none"> <li>• ON/OFF switching</li> <li>• Timed actuation</li> <li>• Motion-based switching</li> <li>• Monitoring of consumption</li> </ul>	
<b>Link to documentation on website:</b>		
<a href="#">GW10856</a>  Glossy White	<a href="#">GW12856</a>  Satin Black	
<a href="#">GW13856</a>  Natural satin beige	<a href="#">GW14856</a>  Titanium	
<a href="#">GW15856</a>  Satin White		
<b>TECHNICAL SPECIFICATIONS</b>		
<b>Auxiliary inputs:</b>	2	
<b>Connection requirements for auxiliary inputs:</b>	Must both be connected to line or neutral. It is not possible to connect one input to the line and the other to the neutral conductor.	
<b>Possible aux input functions:</b>	<ul style="list-style-type: none"> <li>• Control of a local load</li> <li>• Sending of Zigbee commands or statuses: <ul style="list-style-type: none"> <li>➤ ON/OFF/TOGGLE command</li> <li>➤ Timed ON command (stair raiser light)</li> <li>➤ Wired sensor status (binary 0/1)</li> <li>➤ Control of curtains and roller shutters with single or double push-button</li> <li>➤ Dimmer control with single or double push-button</li> <li>➤ Alarm</li> <li>➤ Priority commands for ON/OFF actuators and roller shutters/Venetian blinds</li> <li>➤ Scene command</li> </ul> </li> </ul>	
<b>Max. cable length (auxiliary inputs):</b>	50m	
<b>Power supply:</b>	100 ÷ 240V AC, 50/60 Hz	
<b>Number of modules:</b>	1	
<b>Outdoor transmission radius:</b>	100m	
<b>Type of load:</b>		4-250W (100V AC) 4-500W (240V AC)
		4-50W (100V AC) 4-100W (240V AC)
		4-60W (100V AC) 4-120W (240V AC)
		4-125VA (100V AC) 4-250VA (240V AC)
		
		
<b>Maximum remote sensors limit:</b>	Max 5	

**CONNECTED 1-CHANNEL ON/OFF ACTUATOR WITH CURRENT MEASUREMENT**





<b>Code:</b>	GW10826, GW12826, GW13826, GW14826, GW15826			
<b>Description:</b>	Flush-mounting device with 1 channel for commanding loads with a live NO output contact and measurement of the power draw and energy consumption. The device is equipped with a push-button and local LED for control and display of the load status, with an input (auxiliary axial command, push-button and traditional one-way switch, sensors, etc.) for replicating the local command of the load and for sending Zigbee commands and statuses.			
<b>Functions:</b>	<ul style="list-style-type: none"> <li>• ON/OFF</li> <li>• Toggle</li> <li>• ON (timed) / OFF</li> <li>• Forcing</li> <li>• Scene</li> <li>• Activation associated with presence/motion sensor</li> <li>• Activation associated with binary sensor (0/1)</li> <li>• Energy consumption limit</li> <li>• Measurement of power and energy consumed</li> <li>• SHIFT function (dual function) if the device is installed in an EGO SMART plate</li> </ul>			
<b>Link to documentation on website:</b>				
<a href="#">GW10826</a>	<a href="#">GW12826</a>	<a href="#">GW13826</a>	<a href="#">GW14826</a>	<a href="#">GW15826</a>
				
Glossy White	Satin Black	Natural satin beige	Titanium	Satin White

**TECHNICAL SPECIFICATIONS**

<b>Auxiliary inputs:</b>	1	
<b>Possible auxiliary input functions:</b>	<ul style="list-style-type: none"> <li>• Control of a local load</li> <li>• Sending of Zigbee commands or statuses: <ul style="list-style-type: none"> <li>➢ ON/OFF/TOGGLE command</li> <li>➢ Timed ON command (stair raiser light)</li> <li>➢ Wired sensor status (binary 0/1)</li> <li>➢ Control of curtains and roller shutters with single or double push-button</li> <li>➢ Dimmer control with single or double push-button</li> <li>➢ Alarm</li> <li>➢ Scene command</li> </ul> </li> </ul>	
<b>Max. cable length (auxiliary inputs):</b>	50m	
<b>Power supply:</b>	100 ÷ 240V AC, 50/60 Hz	
<b>Maximum dissipated power:</b>	1.8W (100V AC) 3.2W (240V AC)	
<b>Number of modules:</b>	1	
<b>Outdoor transmission radius:</b>	100m	
<b>Type of load:</b>		800W (100V AC) 1920W (240V AC)
		60W (100V AC) 200W (240V AC)
		80W (100V AC) 200W (240V AC)
		200VA (100V AC) 500VA (240V AC)
	Heat	16(3) A
		16 A (100V AC) 16 A (240V AC)

<i>Safety requirements for installation:</i>	Install circuit breaker of max 16A on the line conductor to protect the device
<i>Maximum remote sensors limit:</i>	Max 5
<i>EGO SMART plate power supply pre-arrangement:</i>	Yes



CONNECTED THERMOSTAT				
<i>Code:</i>	GW10709, GW12709, GW13709, GW14709, GW15709			
<i>Description:</i>	Flush-mounting thermostat for controlling heating/cooling systems with management of the temperature manually and the possibility of turning it off. The thermostat can be used both in connected systems, paired with the Home Gateway GW1x840, as well as in conventional non-connected systems. If used in conventional systems, it does not need to be configured via the app, and some functions will be lost (for details, consult the installation manual).			
<i>Functions:</i>	<ul style="list-style-type: none"> <li>• Two operation types: heating and cooling</li> <li>• Three operating modes: OFF (anti-freeze / high temperature protection), heating, cooling</li> <li>• Regulation of the operating setpoint</li> <li>• Automatic temperature adjustment management* (AUTO mode), activation of weekly temperature control profiles managed via App (cloud)</li> <li>• Control algorithms for 2-way systems: Two points (ON/OFF command), PI proportional (PWM type control)*</li> <li>• One relay output with NO/NC change-over contacts</li> <li>• One input for external NTC temperature sensor**</li> <li>• Zigbee window contact management*</li> <li>• Humidity threshold management*</li> <li>• Dew point*</li> <li>• Display of the unit of temperature measurement in °C or °F</li> </ul> <p>* functions available only in connected mode, paired with the GW1x840 - Home Gateway.  ** both functions are available only in connected mode, paired with GW1x840; in non-connected mode (conventional systems), only compensation of the temperature measured locally is available.</p>			
<i>Link to documentation on website:</i>				
<a href="#">GW10709</a>	<a href="#">GW12709</a>	<a href="#">GW13709</a>	<a href="#">GW14709</a>	<a href="#">GW15709</a>
				
Glossy White	Satin Black	Natural beige	Titanium	Satin White
TECHNICAL SPECIFICATIONS				
<i>Power supply:</i>	100 ÷ 240V AC, 50/60 Hz			
<i>Maximum dissipated power:</i>	<b>Worst case scenario:</b>			
	Display ON (max brightness)			
	Relay ON			
	Network card active			
	Load 5A AC1			
	1.1W (100V AC) 1W (240V AC)			
<i>Number of modules:</i>	2			
<i>Outdoor transmission radius:</i>	100m			
<i>Inputs:</i>	1 input for external temperature sensor (NTC 10K type, e.g. GW10800 and GW1x900)			
<i>Output contact</i>	1 NO/NC 5 A (AC1) 240V AC			
<i>Control algorithms for 2-way systems:</i>	Two points (ON/OFF command)			
	PI proportional (PWM type control)			

<i>T building protection:</i>	Heating 🔥 :	Minimum threshold:	7°C
		Maximum threshold:	35°C
	Cooling ❄️ :	Maximum threshold:	35°C
		Minimum threshold:	7°C
<i>Settable thresholds limit:</i>	Heating 🔥 :	Minimum threshold:	8°C
		Maximum threshold:	31°C
	Cooling ❄️ :	Maximum threshold:	15°C
		Minimum threshold:	34°C
<i>Compatible external NTC temperature sensors:</i>	GW1x900 (device LED power supply missing) GW10800		
<i>External NTC sensor default configuration:</i>	Default GW1x900 with 100% impact		
<i>Control of the boiler or of a zone motorised valve of the heating/cooling system:</i>	Direct control (via local relay)		
	Remote control (via Zigbee actuator)		
<i>Humidity adjustment range:</i>	20% - 90%		
<i>Humidity threshold control algorithm:</i>	Two points control		
<i>No. of remote actuators for humidification/dehumidification control:</i>	2		
<i>Connected mode requirements:</i>	Must be paired with GW1x840 (Home Gateway)		
<i>Compatible Zigbee actuators to be controlled by the thermostat via Zigbee in order to control the boiler and/or motorised valves:</i>	GWA1521	ON/OFF actuator – 1 potential-free channel	
	GWA1522	ON/OFF actuator – 2 channels with 230 V potential	
	GWA1523	ON/OFF actuator with power measurement - 1 channel with 230V potential	
	GW1x826	Connected ON/OFF actuator with energy meter	
	GWA1201 / GWA1202	Connected axial two-way switch module	
<i>Scenes limit:</i>	Max 16		
<i>Window sensors limit:</i>	Max 5		

### 3. SYSTEM SPECIFICATIONS AND ARCHITECTURE

The ChoruSmart system uses wireless connections based on the Zigbee standard protocol. Installing the Home Gateway allows the ChoruSmart system to communicate with the house WiFi network. The home router allows the system to communicate with the cloud, and as a consequence, with the [Home Gateway App](#), giving the user access to all the smart functions offered by the ChoruSmart system (scenes, monitoring of consumption, loads management, cloud/IoT integrations, voice commands integration, use of IFTTT applet).

**NOTE:** the Home Gateway - GW1x840 uses the 2.4 GHz WiFi band. As such, it cannot use 5 GHz WiFi networks.

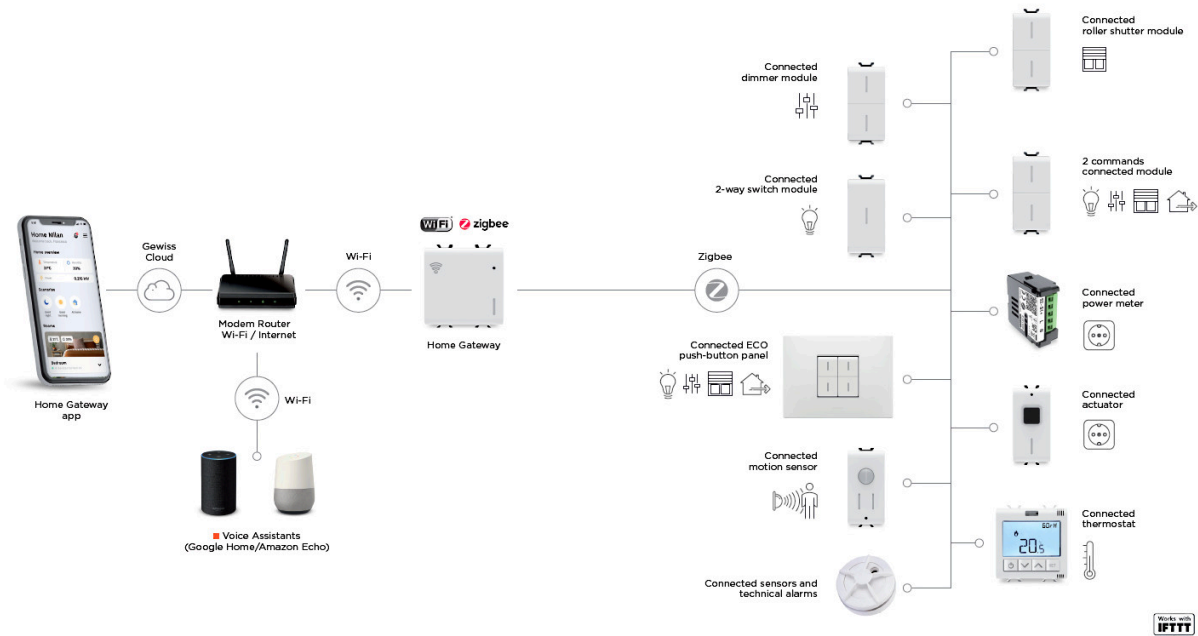

#### BASE FUNCTIONS

The base functions of the traditional system, lights, roller shutters, controlled sockets and temperature regulation, can be implemented in wired mode (recommended) so that they function immediately after installation, before performing the system configuration.

#### SMART FUNCTIONS

The smart functions are obtained via wireless connections via the connected devices: scenes, consumption management, app-based supervision and control, voice commands, cloud/IoT integrations.

**CONNECTED SMART HOME SPECIFICATIONS AND PERFORMANCE:**

<b>MAX NO. OF DEVICES ON NETWORK:</b>	60
<b>MAX. NO. OF STORED SCENES:</b>	16
<b>MAX NO. OF DEVICES IN A SCENE:</b>	Unlimited
<b>MAX NO. OF DEVICES IN A MULTICAST COMMAND<sup>1</sup>:</b>	Unlimited
<b>RANGE (FREE AIR):</b>	100m
<b>MAXIMUM DISTANCE BETWEEN DEVICES:</b>	Max 8 m
<b>WiFi CONNECTION:</b>	2.4 GHz ----- WiFi connection required both for system configuration and for use of the Home Gateway App
<b>INTERNET CONNECTION</b>	----- Internet connection required both for system configuration and for use of the Home Gateway App <sup>2</sup>

<sup>1</sup> **Multicast:** command sent to different devices of the same type which execute it simultaneously

<sup>2</sup> The use of portable routers is not recommended, as they do not guarantee optimum and consistent coverage.

## 4. CONFIGURATION

The Smart Home system is designed to be installed, configured and managed with the Home Gateway App, available for Android and iOS from the relative stores.

For further information on installing the app and configuring a system via smartphone, refer to the guide contained in the section dedicated to the Home Gateway on the website, or scan the QR code below:



User Guide

### 4.1 “TRADITIONAL SYSTEM” FUNCTIONS WHICH CAN BE CONTROLLED BEFORE PERFORMING CONFIGURATION WITH THE APP

It is recommended to implement the ‘traditional’ functions of the system via wired connections (e.g. replicating controls of the same lighting device, connecting the repeating points via wire to the connected two-way switch, the thermostat wired to the boiler/motorised valve and so on) so that once the devices comprising the ChoruSmart system have been installed, these functions can be used immediately even if the app-based configuration (commissioning) has not yet been performed.

The indications of which basic functions to implement via wired connection are given below for each device.

#### ❖ **CONNECTED THERMOSTAT – GW1X709**

The thermostat starts out in non-connected mode and maintains this operating mode until the Zigbee radio is activated by briefly pressing the front button (see instruction and use manual).

It is recommended to wire the connection between the thermostat's output relay and the boiler (or the motorised zone valve which is to be controlled). Before app-based configuration (commissioning) is performed, it is possible to control the ambient temperature and control the boiler or motorised valve connected to the local relay. The user can also modify the required temperature (set point) via the local interface (buttons + display).

The local temperature taken into account for the regulation is that measured by the local sensor in the thermostat (use of the external NTC temperature sensor, where applicable, for temperature compensation is defined during commissioning).

#### ❖ **CONNECTED ON/OFF ACTUATOR WITH ENERGY METER – GW1X826**

Connection of the output relay to the load to control must always be wired.

We recommend:

- To make wired connection via the auxiliary input of any controls to replicate the local control at another location

#### ❖ **CONNECTED MOTION – GW1X856**

We recommend:

- The wired connection of the output relay of the device to the load to be controlled (typically this will be one or more lighting devices)

#### ❖ **CONNECTED AXIAL TWO-WAY SWITCH MODULE – GWA1201/2**

Connection of the output relay to the load to control must always be wired.

We recommend:

- To make wired connection via the auxiliary inputs of any controls to replicate the local control at another location

#### ❖ **CONNECTED AXIAL DIMMER MODULE – GWA1221/2**

Connection of the output to the load to control must always be wired.

We recommend:

- To make wired connection via the auxiliary inputs of any controls to replicate the local control at another location

#### ❖ **CONNECTED AXIAL ROLLER SHUTTER MODULE – GWA1231/2**

Connection of the output to the motor to control must always be wired.

We recommend:

- To make wired connection via the auxiliary inputs of any controls to replicate the local control at another location

**Please note:** the functions of the devices which have not been mentioned will be available only following commissioning.

## 5. FUNCTIONS

### 5.1 BASE FUNCTIONS

It is possible to configure the devices making up the Smart Home system via the Home Gateway App. The configurable parameters are divided into two broad categories: base functions and advanced functions.

The base functions which can be configured for the connected devices are described in the following chapters.

#### 5.1.1. CONTROL OF LIGHTS AND ROLLER SHUTTERS

ON/OFF CONTROL OF LIGHTING DEVICES:

- ON/OFF/TOGGLE command
- Timed ON command (stair raiser light)

DIMMER CONTROL OF LIGHTING DEVICES:

- ON/OFF/TOGGLE command
- Timed ON command (stair raiser light)
- Lighting level control (0-100%)

CONTROL OF CURTAINS/ROLLER SHUTTERS/VENETIAN BLINDS:

- Up/down
- Position (0-100%)
- Louvre tilt (for Venetian blinds only)
- Slat opening-closing (only for roller shutters when closed)

#### 5.1.2. CLIMATE CONTROL

The heating, cooling and climate control is made via the GW1x709 connected thermostat. The thermostat also makes humidity measurement (viewable locally and via app), and it is possible to define (in the configuration) humidity threshold values on the basis of which the thermostat can control (via Zigbee actuators) a dehumidification system. The GW1x709 can manage the entire dwelling as a single zone, or multiple environments independently (multi-zone).

**Single zone:** One thermostat which directly controls the boiler.

**Multi-zone:** The same number of thermostats as the number of climate zones in the dwelling. Each thermostat is connected to the zone solenoid valve.

#### 5.1.3. SCENES

A scene allows multiple commands to be sent to different devices; the controls are executed simultaneously (e.g. "Exit home": switch off all lights and lower all roller shutters).

For the scene management restrictions, see the [System Specification and Performance](#) (page 20).

Scenes can be controlled either via app and via the system buttons (push-button panels, auxiliary inputs and SHIFT function).

#### 5.1.4. PROGRAMMED SCENES

Execution of the scenes (described in the preceding paragraph) can be planned via weekly scheduling (similar to the Timer function), or via the "astronomical clock" function (e.g. switching on or off at dawn or dusk each day).

#### 5.1.5. SENSORS AND ALARMS

The Smart Home system can manage various types of alarms such as flooding alarm, gas leak alarm, smoke alarm, open window alarm etc. The alarm signals are generated by specific sensors. Gewiss offers a huge range of sensors which can be used; the codes for these are given in the table below.

Messages for the alarms detected by these sensors are displayed on the Home Gateway App and/or on the EGO SMART plate once enabled during app-based configuration.

The sensors which can be paired with the various alarm signals are as follows:

ALARMS AVAILABLE ON THE SYSTEM		
ALARM:	USABLE SENSORS:	HOW THE SIGNAL IS ACQUIRED:
<b>Water leak</b>	GWA1514	Acquired directly by Home Gateway via GWA1514 water sensor. Actuators are only required if, following the alarm signal, you wish to close the dwelling's WATER shut-off motorised valve.
<b>Smoke</b>	GWA1512	Acquired directly by Home Gateway via GWA1512 smoke sensor. Actuators are only required if, following the alarm signal, you wish to close a GAS shut-off solenoid valve or other actuators (e.g. fan activation).
<b>Gas leak</b>	GW1x711/2 or any other "traditional" third-party sensor connected to the auxiliary input of any connected device.	Acquired using a conventional gas sensor, with the contact read via a connected device auxiliary input. Closing of the GAS shut-off valve (or other actuations) can be implemented using the local relay of the connected device (which the aux input to which the sensor is connected belongs to), or via Zigbee via a Zigbee actuator.
<b>Window open</b>	GWA1513	Acquired directly by Home Gateway via GWA1513 window/door sensor
<b>Motion</b>	GWA1511; GW1x856	Acquired directly by Home Gateway via GW1x856 or GWA1513 connected motion sensor. Lights or other devices can be controlled via Zigbee actuators.
<b>Weather</b>	Any 'traditional' third-party sensor connected to the auxiliary input of any connected device.	Acquired using a conventional weather sensor, with the contact read via a connected of device auxiliary input. Only actions on roller shutters can be controlled: opening/closing of some or all shutters.
<b>Loss of Cloud Connection</b>	/	Alert generated by the cloud with notification in the app
<b>General alarm</b>	/	As for GAS leakage alarm. But the name of the alarm is not customisable.

For detailed description of the alarm signals displayed on the app via push notifications and on the Smart Plate, refer to the "[Push Notifications](#)" chapter (page **Errore. Il segnalibro non è definito.**).



## 5.2 ADVANCED FUNCTIONS

### 5.2.1. ENERGY MANAGEMENT

The Home Gateway App allows you to monitor the energy consumption and power draw of the entire dwelling or individual loads.

**Entire dwelling:** using the GWA1918 or GWA1916 energy meters, installed after the supplier meter, it is possible to view the power consumption and the energy consumption history by day, week, month and year.

If a solar PV<sup>3</sup> system is connected to the dwelling:

- the power and energy measured by the energy meter installed downline of the grid connection point represent the net energy imported from the grid, net of the solar generation (e.g. if at a given point in time the total loads running in the dwelling are 2 kW and the solar energy production is 1 kW, the energy exchanges with the grid and therefore measured by the meter will be 1 kW).
- In order to measure the power and energy produced by the solar system, an additional GWA1918 or GWA1916 energy meter will need to be installed downline of the solar generation meter.

**Individual loads:** using actuators with GW1x826 and GWA1526 energy meters and connected GWA1201/GWA1202 two-way switches, it is possible to view the power consumption of each individual load (if an energy meter has been installed) and the energy consumption log grouped by load type (lights, socket-outlets, other loads) by day, week, month and year. For loads used with the GWA1523 actuator, it is only possible to view the instantaneous power consumption.

The display of the power/energy produced by the entire system and details of energy consumption by different load type will be available in the next Home Gateway App release (current version at time of printing: 1.2.0).

**Consumption figures are measured directly by the devices and sent to the cloud in real time without any local saving; as such, Internet connectivity dropouts cause the loss of data for the period in which the connection is missing, with consequent loss of data in the display of the consumption log.**

---

<sup>3</sup> PV stands for "Photovoltaic"

### 5.2.2. *TIMER THERMOSTAT FUNCTION*

Using the Home Gateway App, it is possible to define the required temperature profile by setting the operation of the thermostat for each day of the week and for the entire week. Programming the daily temperature profile allows three different temperature ranges to be set (comfort, precomfort and eco). For each of these temperature ranges, the user has the possibility to assign the required target temperature (set point). It is possible to create further temperature ranges in addition to the three default ones. Programming of each day can be copied for the other days of the week, thus speeding up programming.

This function is executed in the cloud, and as such can be performed only with an Internet connection. In the event there is no connection to the cloud, the thermostat will still perform local temperature control, taking the last setpoint value received from the cloud as reference.

## 5.3 CLOUD PLATFORM INTEGRATION

The Connected Smart Home can be integrated with the following cloud platforms.

### AMAZON ALEXA

Integration with the Alexa platform allows the Connected Smart Home to be controlled via voice controls, or to manage them via the Amazon Alexa app (Alexa routines) to integrate them with other third-party IoT objects and systems.

Configuration is performed via the Amazon Alexa app, using the skill dedicated to the Gewiss Connected Smart Home named "*Gewiss Smart*", which automatically imports the system configuration and does not require other operations.

**Please note:** the names given to the devices during configuration of the Connected Smart Home (with Home Gateway App) must be used for the voice commands.

### GOOGLE HOME

Integration with the Google platform allows the Connected Smart Home to be controlled via voice controls, or to manage them via the Google app (Google routines) to integrate them with other third-party IoT objects and systems.

Configuration is performed via Google's Google Home app, using the library dedicated to the Gewiss Connected Smart Home named "*Gewiss Smart*", which automatically imports the system configuration and does not require other operations.

**Please note:** the names given to the devices during configuration of the Connected Smart Home (with Home Gateway App) must be used for the voice commands.

### IFTTT

Integration with the IFTTT platform allows integrations to be created between the Gewiss Smart Home and other IoT devices present on the IFTTT platform (physical devices such as domestic appliances, smartphones and utility applications such as Google Calendar, Telegram etc.).

## 6. AUXILIARY INPUTS OF CONNECTED DEVICES

### 6.1 DESCRIPTION

The auxiliary inputs can be used to replicate the local control of the connected devices to which they belong, or to send Zigbee commands or statuses. Configuration of the auxiliary inputs is performed via the Home Gateway App.

The commands which can be associated with an auxiliary input (during configuration) are:

- Control of a local load
- Sending of Zigbee commands:
  - ON/OFF/TOGGLE command
  - Timed ON command (stair raiser light)
  - Wired sensor status (binary 0/1)
  - Control of curtains and roller shutters with single or double push-button
  - Dimmer control with single or double push-button
  - Alarm
  - Scene command
- Reading of Zigbee sensor status:
  - Gas sensor
  - Motion sensor
  - Weather alarm sensor
  - Other sensor (any type of sensor, connecting the output contact to the input)

The readings taken by the sensors listed above can be notified on the App and/or Smart Plate.

The following table contains details of the number of auxiliary inputs which the different connected devices are equipped with.

AUXILIARY INPUTS		
CODE	DEVICE NAME	NO. OF AUX. INPUTS
GW1x826	CONNECTED 1-CHANNEL ON/OFF ACTUATOR WITH CURRENT MEASUREMENT	1
GW1x856	MOTION SENSOR	2
GW1201/2	CONNECTED AXIAL TWO-WAY SWITCH MODULE	2
GWA1221/2	CONNECTED AXIAL DIMMER MODULE	2
GWA1231/2	CONNECTED AXIAL ROLLER SHUTTER MODULE	2
GWA1241/2	CONNECTED AXIAL 2-COMMAND MODULE	2

### 6.2 MAXIMUM CONNECTION LENGTH

The maximum connection length for the auxiliary inputs is 50 metres.

MAX. CABLE LENGTH (AUXILIARY INPUTS)		
GW1x826	CONNECTED 1-CHANNEL ON/OFF ACTUATOR WITH CURRENT MEASUREMENT	50m
GW1x856	MOTION SENSOR	50m
GWA1201/2	CONNECTED AXIAL TWO-WAY SWITCH MODULE	50m
GWA1221/2	CONNECTED AXIAL DIMMER MODULE	50m
GWA1231/2	CONNECTED AXIAL ROLLER SHUTTER MODULE	50m
GWA1241/2	CONNECTED AXIAL 2-COMMAND MODULE	50m

### 6.3 DESCRIPTION OF FUNCTIONS WHICH CAN BE ASSOCIATED WITH THE AUXILIARY INPUTS

Configuration of the auxiliary inputs must be made in accordance with the control device being connected to them:

- **Switch:** controls a single device or a group of homogeneous devices (all lights etc.)
- **Button:** controls a single device or a group of homogeneous devices (all lights or all roller shutters etc.), or a scene
- **Sensor:** it is possible to choose between four different types of sensors:

- **Motion sensor**
- **Weather alarm sensor**
- **Generic sensor**
- **Gas sensor**

Depending on the type of sensor chosen, certain devices and not others can be associated.

#### 6.4 FACTORY CONFIGURATION

In their factory configuration, the devices have the auxiliary inputs set to replicate the local command. Only by configuring the auxiliary inputs via the Home Gateway App will it be possible to use them to send Zigbee commands or statuses.

In order to reset the devices to their factory defaults, it will be necessary to press and hold the button to open the Zigbee network for over 10 seconds. Refer to the user manuals to locate the button on the individual devices.

## 7. EGO SMART PLATE

Plate equipped with LED matrix and RGB strips allowing icons and messages to be displayed. The plate is also equipped with a proximity sensor, through which the “SHIFT” function is activated.

### 7.1 POWER SUPPLY

The EGO SMART plate must be powered by one of the following devices, which must be connected inside the same backbox that the plate is installed on:

PRODUCT CODE	NAME
GW1x826	CONNECTED 1-CHANNEL ON/OFF ACTUATOR WITH CURRENT MEASUREMENT
GWA1201/2	CONNECTED AXIAL TWO-WAY SWITCH MODULE
GWA1231/2	CONNECTED AXIAL ROLLER SHUTTER MODULE
GWA1241/2	CONNECTED AXIAL 2-COMMAND MODULE
GWA1700	EGO SMART POWER SUPPLY AND COMMUNICATION PLATE

### 7.2 SHIFT FUNCTION OR DUAL FUNCTION

The table lists the devices which support the SHIFT function if installed in the Smart Plate:

PRODUCT CODE	NAME	SHIFT FUNCTION
GW1x826	CONNECTED 1-CHANNEL ON/OFF ACTUATOR WITH CURRENT MEASUREMENT	Yes (1 Zigbee command)
GWA1201/2	CONNECTED AXIAL TWO-WAY SWITCH MODULE	Yes (1 Zigbee command)
GWA1221/2	CONNECTED AXIAL DIMMER MODULE	Yes (2 Zigbee commands)
GWA1231/2	CONNECTED AXIAL ROLLER SHUTTER MODULE	Yes (2 Zigbee commands)
GWA1241/2	CONNECTED AXIAL 2-COMMAND MODULE	Yes (2 Zigbee commands)

Once the SHIFT function has been activated, the above-mentioned devices can send Zigbee commands independent from the device function via the local buttons: scene commands, ON/OFF and light dimming commands, roller shutter commands etc.

### 7.3 WARNING AND ALARM SIGNALLING

Via the Home Gateway App it is possible to enable or disable display of notifications and alarms on the Smart Plate (“**Manage notifications**” → “**EGO SMART plate**”). Refer to the app manual.

The notifications and alarms which can be displayed are listed below:

## MESSAGES AND ALARMS DISPLAYED BY THE SMART PLATE

Water sensor alarm (GWA1514):	Water leakage
Smoke / Fire sensor alarm (GWA1512):	Smoke detected
Gas sensor alarm (GW1x711/2):	Gas detected
Energy meter (GWA1918) - Consumption limit exceeded:	Max consumption exceeded
Energy meter (GWA1918) - Load shedding activated:	Load switch-off in progress
16AX actuator - Consumption lit exceeded (for single energy socket):	Socket max consumption exceeded
16AX actuator - Socket switched off:	Socket switched-off
Door / Window sensor - Door or window opened:	Door or window opened
Motion sensor (GWA1513) - Motion detected:	Motion detected
Thermostat - High humidity threshold exceeded:	High humidity level
Thermostat - Low humidity threshold exceeded:	Low humidity level
Welcome message displayed with the "At home" scenario":	Hello
Goodbye message displayed with the "I'm going out" scenario":	Goodbye (French window open notification: for this function, French window sensors must be installed)
Roller shutter - Weather alarm detected:	Weather alarm

## 8. BATTERY SENSORS

**Initial system configuration (commissioning):** it is strongly recommended that the battery sensors are joined to the Zigbee network one at a time, after inserting all grid-powered devices.

**Please note:** if a battery device is not new with factory settings, meaning that it had been joined to another system, this must be reset before proceeding with commissioning of the new system.

**Battery state of charge:** this can be viewed by bringing up the battery device page in the Home Gateway App (“**Manage the home**” → “**Rooms and devices**” → select the room in which the battery device has been installed → click on the battery device): the battery charge level is shown in the “*Information*” section.



## 9. ECO CONNECTED 4-COMMAND PUSH-BUTTON PANELS MODULE – ZIGBEE

**Initial system configuration (commissioning):** it is strongly recommended that the push-button panels are joined to the Zigbee network only after inserting all grid-powered devices.

The push-button panels are bound (for the purposes of signal repeating) to the powered devices (routers) closest to it at the time of configuration; as such, if the push-button panel is to be used at a distance excessively far from the 'router' devices where it was located in the configuration phase, the signal could be too weak and as a consequence the commands might not reach the furthest devices.

**Commands possible with individual buttons:** all commands (ON/OFF lights, dimmer, shutter etc.) can be performed, with the **EXCEPTION OF MULTIPLE COMMANDS**.

**Actuators which cannot be controlled by the push-button panel:** the push-button panel cannot be used to control the following actuators: GWA1521, GWA1522, GWA1523, GWA1526, GWA1531 actuators and the GWA1916 local relay.

## 10. LEGACY ZIGBEE DEVICES COMPATIBLE WITH CONNECTED SMART HOME

All pre-existing Zigbee devices (GWA1502, GWA1511, GWA1513, GWA1521, GWA1514, GWA1521, GWA1522, GWA1523, GWA1531, GWA1526), with the exception of the GWA1501 device, are already compatible and can be used in the Connected Smart Home ecosystem. They can therefore be managed and configured with the Home Gateway App. The GWA1501 device will be compatible with the Connected Smart Home with future app releases.

## 11. APP

The Smart Home system is designed to be managed via the Home Gateway App .<sup>4</sup> The app is required both to control and to configure the system.

The app is designed to guide the user easily and intuitively through all the different steps required both to create and configure the system, and to control it. You simply need to follow the instructions in the app and refer to the dedicated manual.

### 11.1 USER PROFILES AND ACCESS PERMISSIONS

After creating the system, it is possible to add new users to it. There are three roles which can be assigned to a new user:

- Guest
- Installer
- Administrator

#### SYSTEM USER ROLES

Guest:	Can control all system functions (lights, shutters, scenes etc.). Cannot modify the system configuration (scenes, temperature regulation profiles etc.). Cannot change the role assigned to each user of the system. Cannot add users to the system.
Installer:	Default role assigned to the user who configures the system for the first time. Has complete control of the system both in terms of control of the functions and for configuration. Can add administrator and installer users.  In general, when commissioning is complete and the installer hands over the installation, they assign an administrator user (on customer instruction).
Administrator:	Has complete control of the system both in terms of control of the functions and for configuration. Can add administrator, installer and guest users. Can delete or edit the role of any user type. Can disable installer users without deleting them.

It is possible to check the role assigned to each user in the “**Manage users**” section of the Home Gateway App.

### 11.2 PUSH NOTIFICATIONS – NOTIFICATIONS AND ALARMS

Via the Home Gateway App it is possible to enable or disable reception of various types of notifications and alarms.

In particular, you can:

- Enable/disable push notifications
- Enable/disable reception of push notifications relating to users being added or removed from the system
- Enable/disable reception of push notifications relating to an installer being added or removed from the system
- Enable/disable reception of notifications relating to the loss of connection of the gateway or another system device













The “**Manage notifications**” page allows you to manage both notifications and warnings displayed by the app and those displayed by the EGO SMART plates. It is possible to modify the settings of the notifications or warnings













<sup>4</sup> The Home Gateway App can be downloaded free of charge from the main app stores (Play Store and App store).





received directly on the mobile device by selecting “**Notification center**”, while management of notifications and warnings displayed by the EGO SMART plates is found in “**EGO SMART plate**”.

The log of alarms and warnings generated by the system itself is recorded on the app. The log can be viewed on the “**Notifications**” page.







The push notifications relating to system alarms/notifications are listed below in the table

WARNINGS AND ALARMS			
TYPE	ICON	NOTIFICATION CENTRE MESSAGES	DESCRIPTION
DEVICE		<b>&lt;Installation_Name&gt;: device cannot be reached</b> <Device_Name> cannot be reached. Possible fault or lack of signal.	Device unreachable
		<b>&lt;Installation_Name&gt;: &lt;Device_Name&gt; is functioning again</b>	Device reachable again
		<b>&lt;Installation_Name&gt;: Device with low battery</b> Replace device battery <Device_Name>.	Device with low battery
		<b>&lt;Installation_Name&gt;: Device battery restored</b> Battery restored in device <Device_Name>.	Battery alarm returned
PLANT		<b>&lt;Installation_Name&gt;: cannot connect with the system</b> Possible fault or blackout, or no Internet connection.	Unable to connect to the system
		<b>&lt;Installation_Name&gt;</b> is online again	Plant back online
GENERIC		<b>&lt;Installation_Name&gt;: General alarm</b> General alarm from room <Room_Name>.	General alarm
		<b>&lt;Installation_Name&gt;: No general alarm detected</b> General alarm from room <Room_Name> switched off.	Generic alarm returned
HUMIDITY		<b>&lt;Installation_Name&gt;: maximum humidity threshold exceeded</b> High humidity in the room <Room_Name>.	Max. humidity threshold exceeded alarm
		<b>&lt;Installation_Name&gt;: minimum humidity setting exceeded</b> Low humidity in the room <Room_Name>.	Lowered humidity alarm
		<b>&lt;Installation_Name&gt;: humidity value within normal range</b> Acceptable range humidity in the room <Room_Name>.	Humidity alarm returned
LOAD		<b>&lt;Installation_Name&gt;: Load not present</b> The <Device_Name> in the room <Room_Name> is not connected to anything.	Load not present

		<p><b>&lt;Installation_Name&gt;: Load present</b></p> <p>The &lt;Device_Name&gt; in the room &lt;Room_Name&gt; is now connected.</p>	Load present
METEEO		<p><b>&lt;Installation_Name&gt;: Weather alarm in progress</b></p>	Weather alarm
		<p><b>&lt;Installation_Name&gt;: No weather alarm detected</b></p>	Weather alert returned
MOVEMENTS		<p><b>&lt;Installation_Name&gt;: Movement detected</b></p> <p>The &lt;Device_Name&gt; in the room &lt;Room_Name&gt; detected a movement.</p>	Motion detection alarm
		<p><b>&lt;Installation_Name&gt;: No movement alarm detected</b></p> <p>Movements are no longer detected in the room &lt;Room_Name&gt;.</p>	Movement detection alarm returned
DOOR/WINDOW		<p><b>&lt;Installation_Name&gt;: Door/window open.</b></p> <p>The &lt;Device_Name&gt; in the room &lt;Room_Name&gt; detected an open door/window.</p>	Door or window open alarm
		<p><b>&lt;Installation_Name&gt;: No door/window alarm detected</b></p> <p>There is no open door/window in the room &lt;Room_Name&gt;.</p>	Door or window open alarm returned
SMOKE		<p><b>&lt;Installation_Name&gt;: Attention, fire alarm</b></p> <p>The sensor has detected smoke in the room &lt;Room_Name&gt;.</p>	Smoke alarm
		<p><b>&lt;Installation_Name&gt;: No fire alarm detected</b></p> <p>No smoke detected in the room &lt;Room_Name&gt;.</p>	Smoke alarm returned
WATER		<p><b>&lt;Installation_Name&gt;: Water leak alarm</b></p> <p>The sensor detected a leak in the room &lt;Room_Name&gt;.</p>	Water leakage alarm
		<p><b>&lt;Installation_Name&gt;: No water leak alarm detected</b></p> <p>No water leak in the room &lt;Room_Name&gt;.</p>	Water leakage alarm returned
GAS		<p><b>&lt;Installation_Name&gt;: Gas leak alarm</b></p> <p>The sensor has detected gas in the room &lt;Room_Name&gt;.</p>	Gas leakage alarm
		<p><b>&lt;Installation_Name&gt;: No gas leak alarm detected</b></p> <p>No gas detected in the room &lt;Room_Name&gt;.</p>	Gas leak alarm returned

CURRENT THRESHOLD		<p><b>&lt;Installation_Name&gt;: Current threshold exceeded</b></p> <p>&lt;Device_Name&gt; in the room &lt;Room_Name&gt;: exceeded the set limit.</p>	Over current threshold alarm
		<p><b>&lt;Installation_Name&gt;: Current limit exceedance now returned</b></p> <p>&lt;Device_Name&gt; in the room &lt;Room_Name&gt; has normal consumption.</p>	Over current threshold alarm returned
		<p><b>&lt;Installation_Name&gt;: Load shedding for exceeding threshold limit</b></p> <p>&lt;Device_Name&gt; in the room &lt;Room_Name&gt; exceeded the threshold limit and was disconnected.</p>	Load shedding alarm for exceeding threshold limit
OVERLOAD		<p><b>&lt;Installation_Name&gt;: Load disconnection due to current overload</b></p> <p>&lt;Device_Name&gt; in the room &lt;Room_Name&gt; draws too much current. Load disconnected.</p>	Load shedding for current overload alarm
		<p><b>&lt;Installation_Name&gt;: Current overload now returned</b></p> <p>&lt;Device_Name&gt; in the room &lt;Room_Name&gt;: consumption is within the norm.</p>	Loads restored, consumption below threshold
CONSUMPTION		<p><b>&lt;Installation_Name&gt;: consumption data deleted</b></p> <p>The user &lt;Nome utente&gt; deleted the energy consumption data collected by the system.</p>	Deleted consumption data

Push notifications related to plant management are shown in the table below

PLANT MANAGEMENT ALERTS			
TYPE	ICON	NOTIFICATION CENTRE MESSAGES	DESCRIPTION
		<p><b>Welcome to the new home!</b> You have been added to: &lt;Installation_Name&gt;.</p>	Welcome Message
USER MANAGEMENT		<p><b>&lt;Installation_Name&gt;: New user</b> &lt;User_Name&gt; has been added to the system with the role of &lt;role&gt;.</p>	New user added
		<p><b>&lt;Installation_Name&gt;: A user has been deleted from the system</b> &lt;User_Name&gt; has been removed from the system.</p>	User removed from the system
		<p><b>You have been eliminated from an installation</b> You no longer have access to: &lt;Installation_Name&gt;.</p>	Users removed from the system
		<p><b>&lt;Installation_Name&gt;: All installers have been enabled</b> The installers have access to the system again.</p>	All installers are qualified
		<p><b>&lt;Installation_Name&gt;: All installers have been disabled</b> The installers no longer have access to the system.</p>	All installers disabled

## 12. APPLICATION EXAMPLES – CONNECTION DIAGRAMS

This chapter contains a series of example connection diagrams which can be used, by way of example, to understand how to design your own system.

### 12.1 TRANSFORMING AN EXISTING SYSTEM INTO A SMART SYSTEM: CONNECTED AXIAL 2-WAY SWITCH MODULE

The two inputs of the connected axial 2-way switch module can be connected to NO contacts (e.g. auxiliary axial modules, conventional buttons and switches, sensors) and be used independently of each other to replicate the local load control or to send generic Zigbee commands or statuses to the system (e.g. ON/OFF, scenes). Their functions are set during the configuration phases.

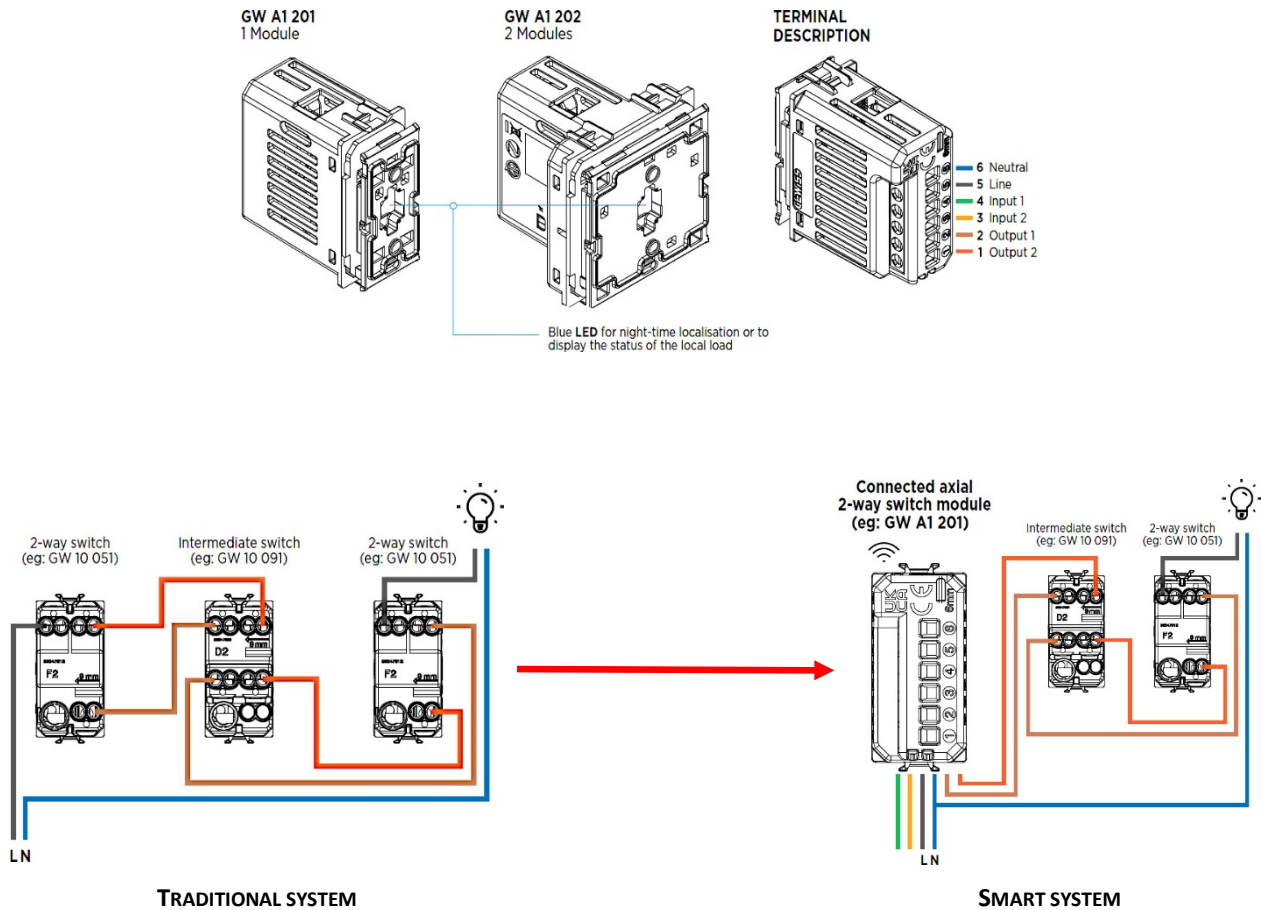



## 12.2 LIGHT CIRCUIT CONTROLLED BY FOUR POINTS WITH CENTRALISED OFF COMMAND: CONNECTED AXIAL 2-WAY SWITCH MODULE

Connection example of the connected axial 2-way switch module to create a lighting circuit controlled from 4 points, with the addition of a centralised\* OFF command.

*\* Alternatively, the command can be configured to send any Zigbee command (scenes, lights ON/OFF, dimmer etc.)*

When creating new systems, the use of the auxiliary inputs to replicate the local command or carry out Zigbee commands allows for significant simplification of all wiring operations and optimisation of the number of components, thus reducing system cost.

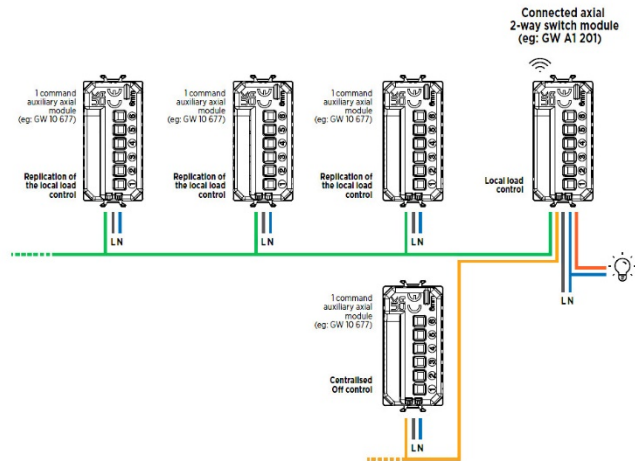

### 12.3 TRANSFORMING AN EXISTING SYSTEM INTO A SMART SYSTEM: CONNECTED AXIAL DIMMER MODULE

Connection example of connected axial dimmer module to transform an existing traditional system into a smart system or for the creation of a new system.

The two inputs of the connected axial dimmer module can be connected to NO contacts (e.g. auxiliary axial modules, traditional buttons and switches, sensors) and be used in pairs to replicate the local lighting load control or to send generic Zigbee commands or statuses to the system (e.g. ON/OFF, dimmer, shutters, scenes), or separately, with one of the two inputs, to replicate the command for local load control and the other input to send a generic Zigbee command or status to the system. Their functions are set during the configuration phases.

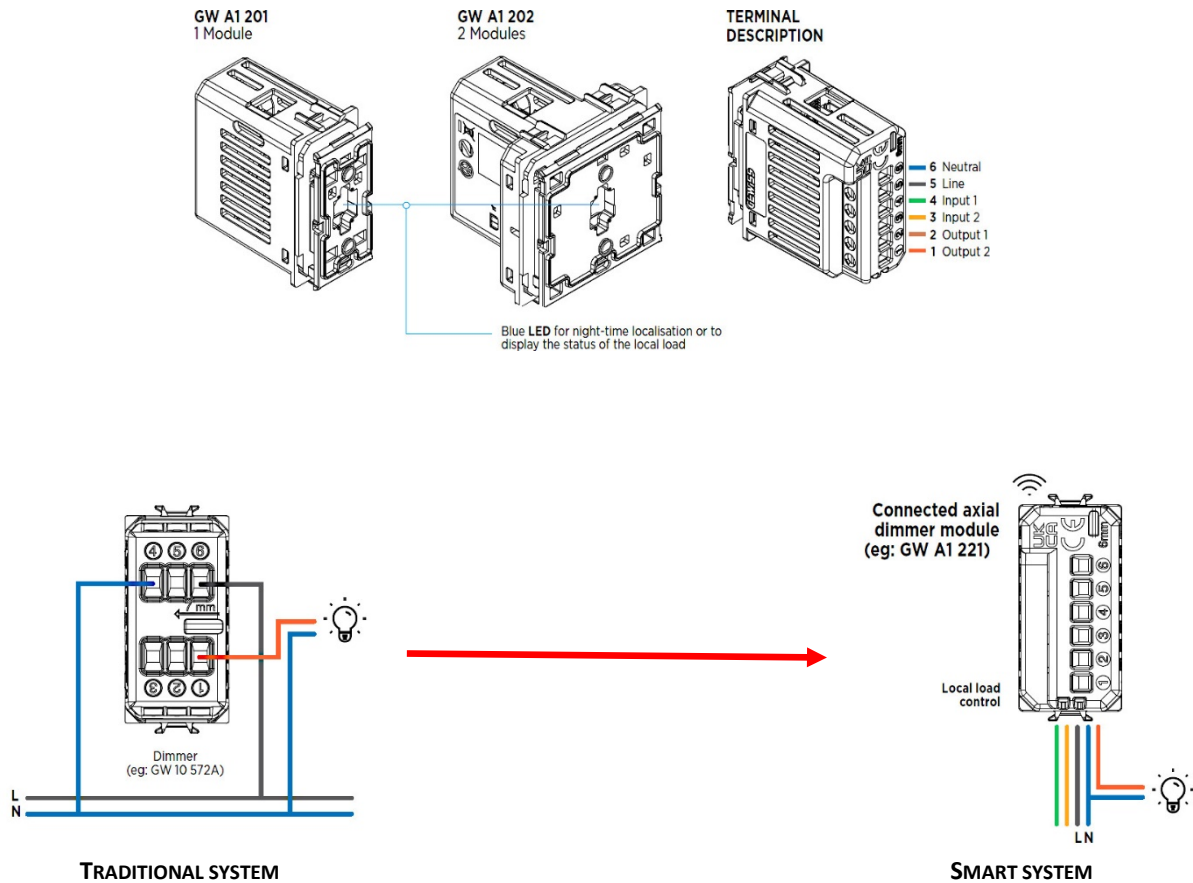

### 12.4 CONNECTION DIAGRAM: MULTI-POINT LIGHTING COMMAND AND CONTROL

Example of lighting load command and control of a from multiple points.

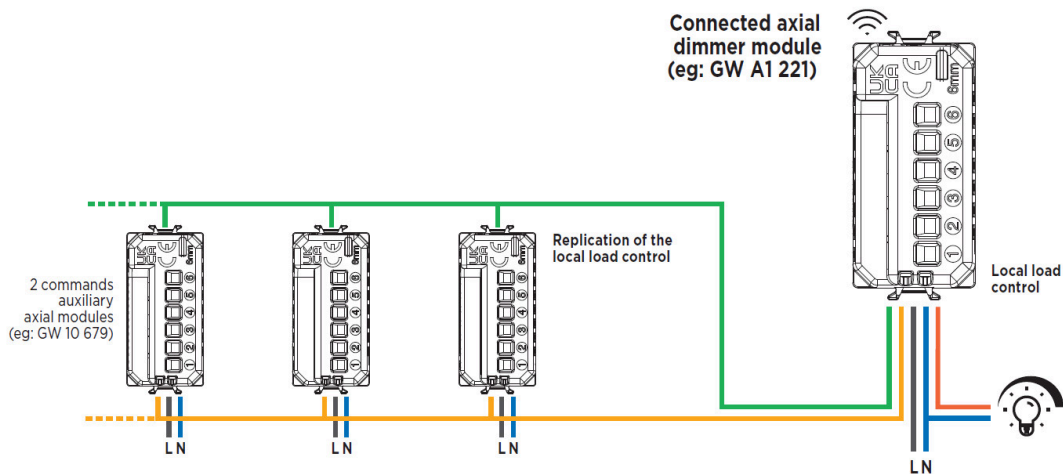

## 12.5 EXIT HOME SCENE COMMAND TO TURN OFF LIGHTS AND CLOSE SHUTTERS/ VENETIAN BLINDS: AUXILIARY AXIAL MODULE

Example of creating an exit home scene, to turn off the lights and close roller shutters/Venetian blinds, using a 1-command auxiliary axial module\*.

\* To create the scene command it is also possible to use connected 2-command axial modules (e.g. GWA1241) and/or ECO push-button panels (e.g. GWA1291).

The auxiliary axial commands used to duplicate or centralise the control of the lighting loads do not necessarily have to connect to the connected dimmer modules which manage the loads, but can be connected to the two auxiliary inputs of any smart device in the system.

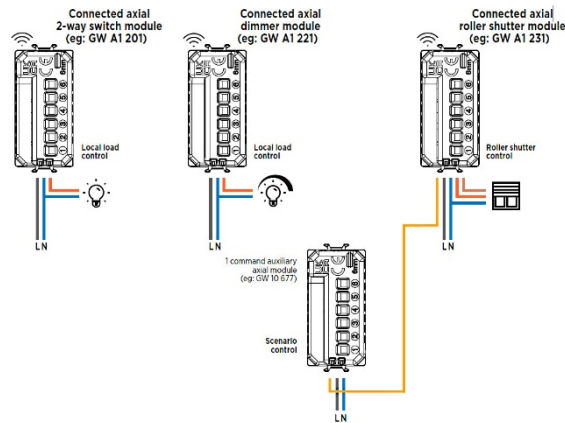

## 12.6 TRANSFORMING AN EXISTING SYSTEM INTO A SMART SYSTEM: CONNECTED AXIAL ROLLER SHUTTER MODULE

Connection example of connected axial roller shutter module to transform an existing traditional system into a smart system or for the creation of a new system.

The two inputs of the connected axial roller shutter module can be connected to NO contacts (e.g. auxiliary axial modules, traditional buttons and switches, sensors) and be used in pairs to replicate the control of the roller shutter/Venetian blind or to send generic Zigbee commands or statuses to the system (e.g. ON/OFF, dimmer, shutters, scenes), or separately, with one of the two inputs, to replicate the command for control of the electric motor and the other input to send a generic Zigbee command or status to the system. Their functions are set during the configuration phases.

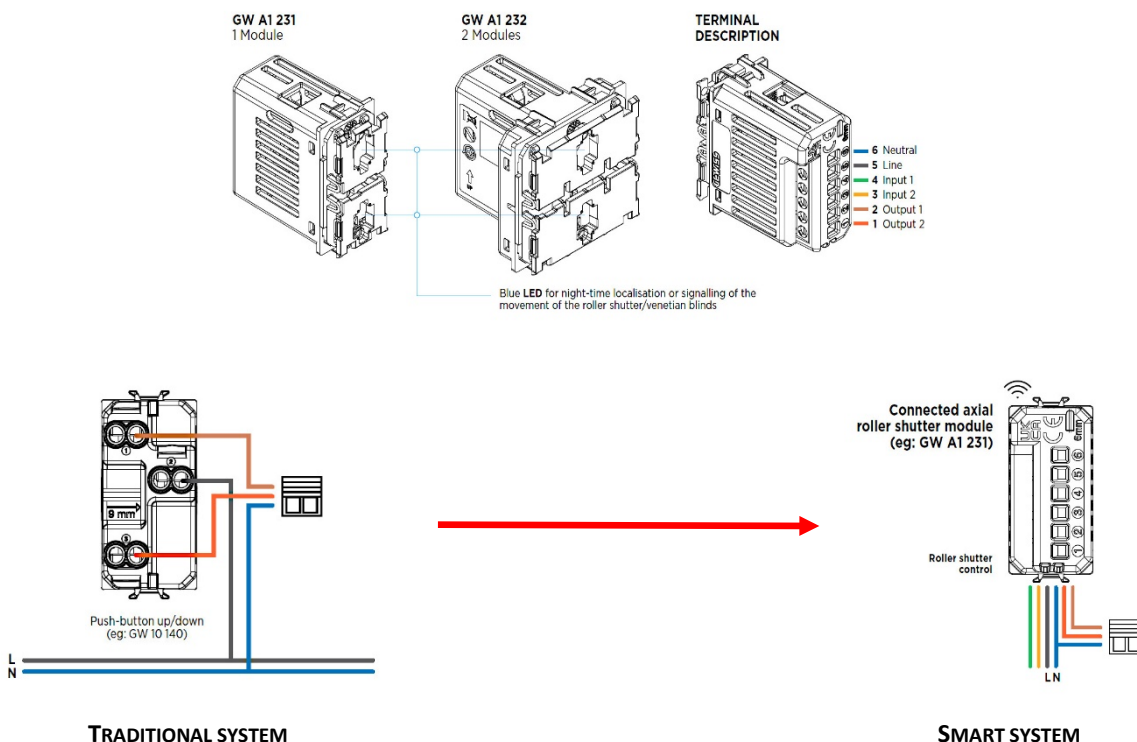

## 12.7 CONNECTION DIAGRAM FOR CONTROL FROM MULTIPLE POINTS OF ONE ROLLER SHUTTER/VENETIAN BLIND

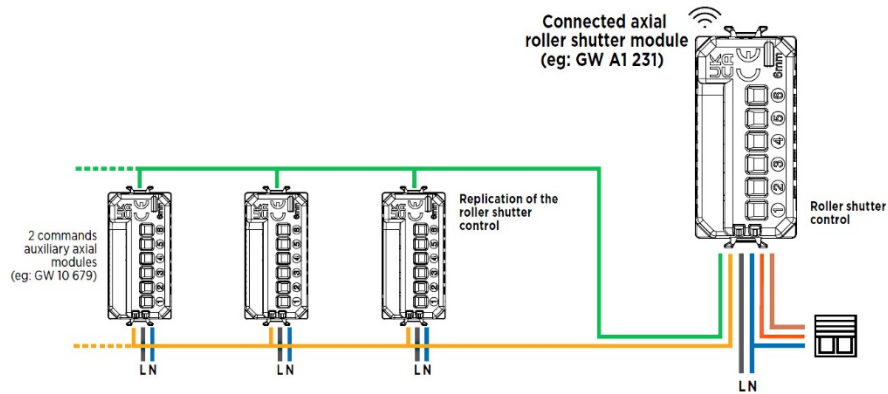

## 12.8 CENTRALISED CONTROL OF A GROUP OF ROLLER SHUTTERS/VENETIAN BLINDS

Centralised raising/lowering control of a group of roller shutters/Venetian blinds

The auxiliary axial commands used to duplicate or centralise the control of the roller shutters/Venetian blinds do not necessarily have to connect to the connected modules which manage the shutters/blinds, but can be connected to the two auxiliary inputs of any smart device in the system.

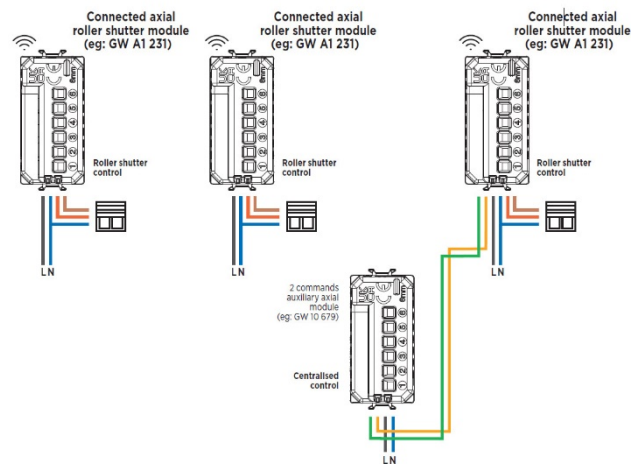

## 12.9 CONNECTION DIAGRAM: 2 COMMANDS CONNECTED AXIAL MODULE

Connection of the 2 commands connected axial module to perform two scenes (input and output) from two distinct points.

In the diagram shown it is possible to use a 2 commands auxiliary axial module (e.g. GW10679) or, alternatively, 1 command auxiliary axial modules (e.g. GW10677), connected either to input 1 or input 2.

The two inputs of the 2 commands connected auxiliary axial module can be connected to NO contacts (e.g. auxiliary axial modules, conventional buttons and switches, sensors) and be used independently of each other to send generic Zigbee commands or statuses to the system (e.g. ON/OFF, scenes). Their functions are set during the configuration phases.

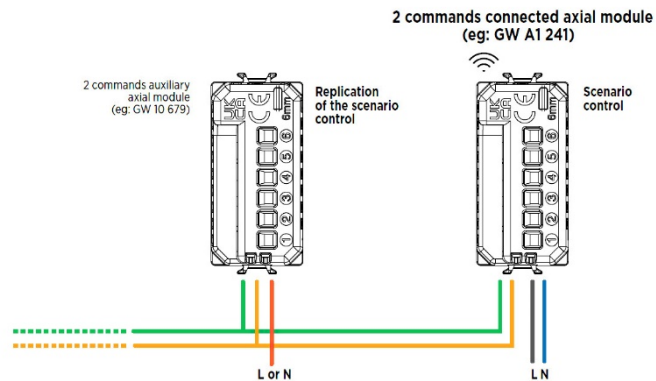
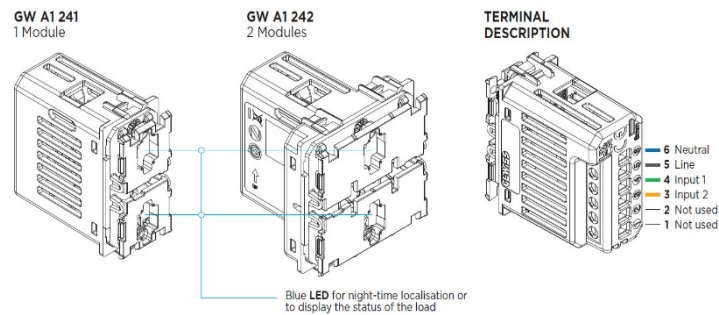

## 12.10 CONNECTION DIAGRAM: CONTROLLED SOCKET-OUTLETS

Connection of the connected 1-channel on/off actuator to a power outlet to turn it into a controlled socket-outlet.

In the diagram shown, the input of the connected 1-channel on/off actuator can be used to connect one or more 1-command auxiliary axial modules in parallel (e.g. GW10677) and configure them to replicate the local load control.

The input of the connected 1-channel on/off actuator can be connected to NO contacts (e.g. auxiliary axial modules, traditional buttons and switches, sensors) and be used to replicate the local load control or, alternatively, to send a generic Zigbee command (e.g. ON/OFF, dimmer, shutters, scenes) or status to the system. Its function is set during the configuration phases.

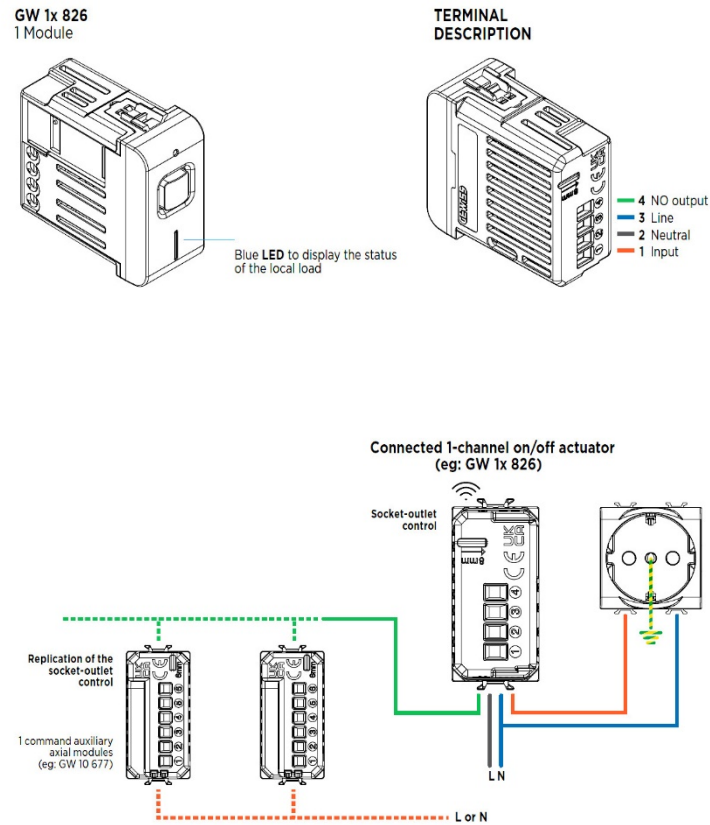

## 12.11 CONNECTION DIAGRAM: CONNECTED ENERGY METER

Connection of the connected energy meter to measure the draw of the single-phase line and control the connected actuators in the system to control the loads.

GW A1 918  
1 Module

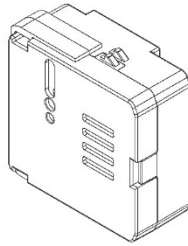

TERMINAL  
DESCRIPTION

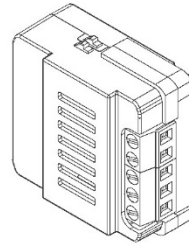

- 5 Neutral
- 4 Line
- 3 Not used
- 2 Input +
- 1 Input -

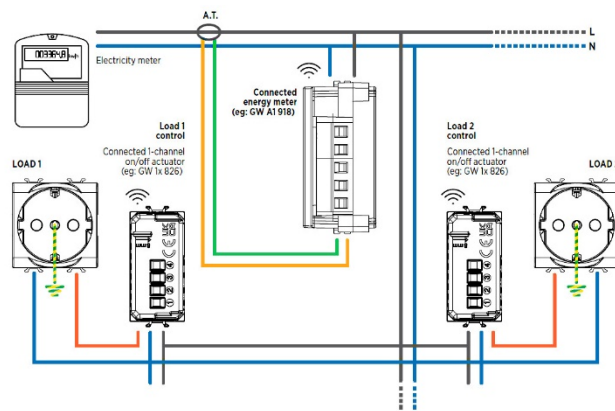

## 12.12 CONNECTION DIAGRAM: CONNECTED MOTION SENSOR

Connection of the connected motion sensor to manage a lighting load with the addition of the local command in two points.

In the diagram shown, input 2 of the connected motion sensor can be used to connect one or more 1 command auxiliary axial modules in parallel (e.g. GW10677) and configure them to send a generic Zigbee command or status to the system (e.g. ON/OFF, scene).

The two inputs of the connected motion sensor can be connected to NO contacts (e.g. auxiliary axial modules, conventional buttons and switches, sensors) and be used independently of each other to replicate the local load control or to send generic Zigbee commands or statuses to the system (e.g. ON/OFF, scenes). Their functions are set during the configuration phases.

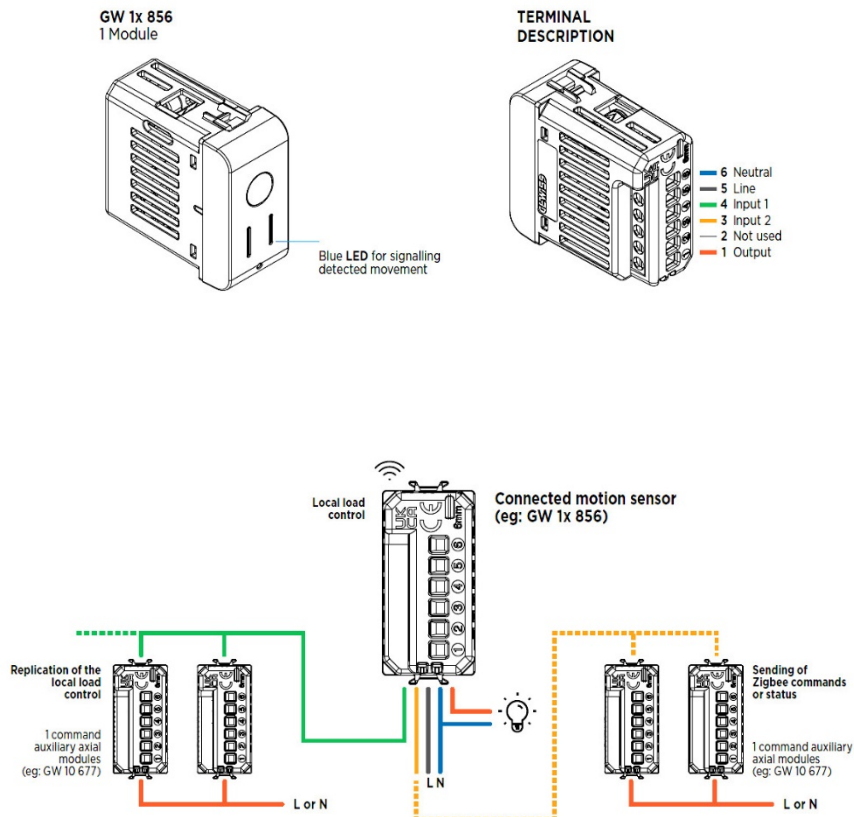



### 12.13 CONNECTION DIAGRAM: CONNECTED THERMOSTAT

Connection of the connected thermostat to control the motorised zone valve via the relay output and a dehumidification system via a connected 1-channel on/off actuator.

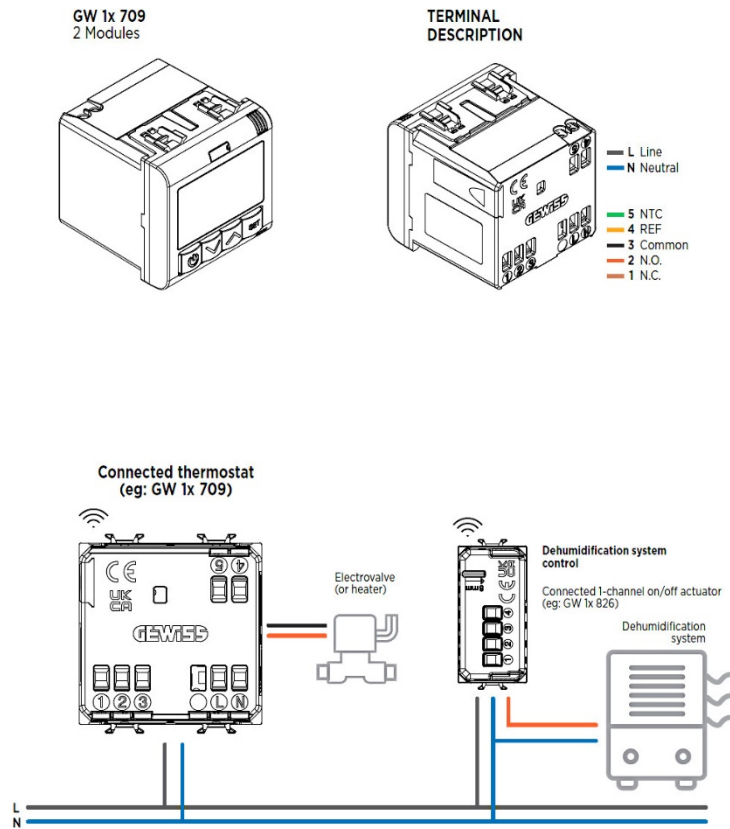

### 12.14 WIRELESS (ZIGBEE) SENSORS: FLOOD ALARM

Connection of wireless sensor for detection of water leaks, using a connected device to control the water shut-off solenoid valve via the on-board contact. The alarm can also be displayed on the smart plate.



For applications not requiring control of the solenoid valve, but only the sending of alarm notifications via App or on the EGO SMART plate display, no actuator is required: the alarm is managed and acquired directly by the Home Gateway. In the same way, the GWA1512 sensor can be used to manage smoke alarms.

### 12.15 WIRED SENSORS: GAS ALARM

Connection of a wired sensor for detection of gas leaks. The output contact of the sensor is acquired by the system via the auxiliary input of a connected device. In the example, the same output contact is also used to control the gas shut-off solenoid valve.

The alarm can also be displayed on the smart plate and on the app.



### 12.16 WIRELESS (ZIGBEE) SENSORS + WIRED SENSORS

Connection of a wireless sensor for smoke detection and a wired sensor for detection of gas leaks.

Following the smoke alarm, a ventilation system is activated using a connected actuator, while following the gas leak alarm the sensor contact directly controls the dwelling's gas shut-off solenoid valve.

The alarm can also be displayed on the smart plate and on the app.

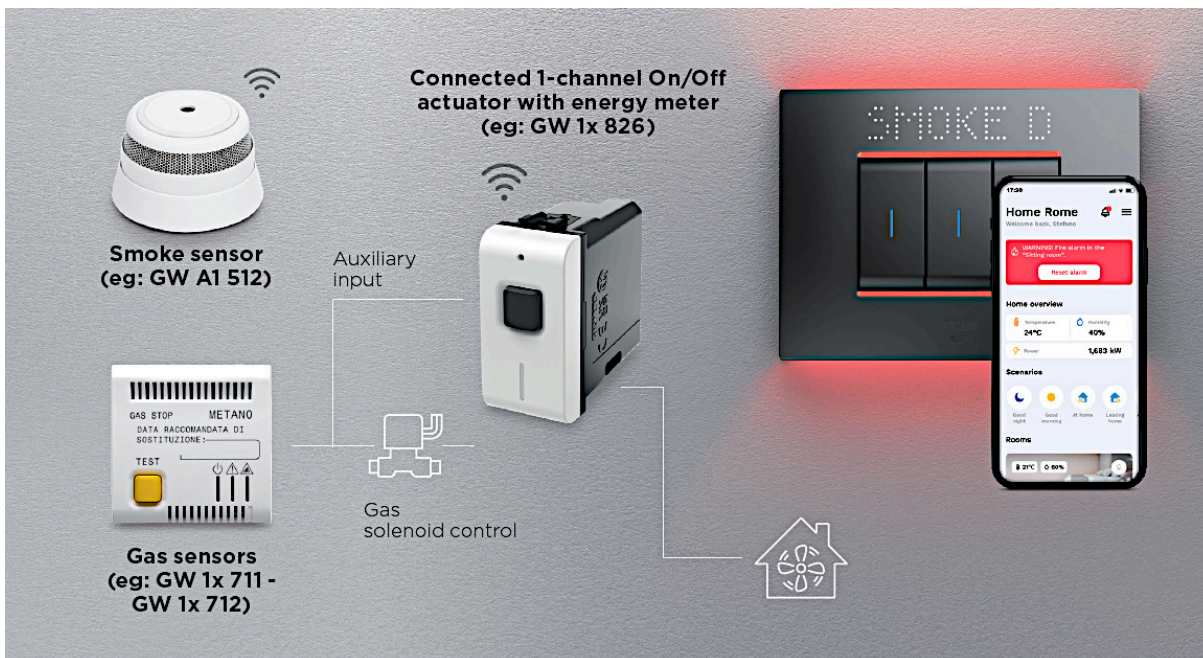



## 12.17 OPEN WINDOW NOTIFICATION

When the exit home scene is run, the EGO SMART plate notifies the user of any open windows. To this end it is necessary to use the connected GWA1513 sensor on all windows to be monitored.

The alarm can also be displayed on the smart plate and on the app.



## 13. INSTALLATION

### 13.1 DISTANCES

In the design and installation of the system, it is essential to keep in mind the distances between the various Zigbee devices, because this will have an influence on the quality of the signal and on the effectiveness of the communication between the devices.

#### DISTANCES

<b>INDOOR:</b>	8m
<i>Notes:</i>	The distance given here is approximate. The following factors must also be taken into account in the calculations: <ul style="list-style-type: none"><li>• Thickness of internal walls</li><li>• Internal wall material</li><li>• Use of shielding materials</li><li>• Presence of devices which could generate interference</li></ul> it is always good practice to carry out tests in advance to determine the maximum effective achievable distance in the specific building in which the system will be installed.
<b>OUTDOOR:</b>	100m
<i>Notes:</i>	This distance is a free-field value, that is without any elements which could limit, disturb or impede the propagation of the radio signal.

### 13.2 INSTALLATION NOTES

#### **Distribution of Zigbee devices in the system – avoid “funnel”-type distributions:**

The Zigbee devices will be distributed in the system (in the different rooms and floors) on the basis of system requirements.

Nevertheless, on the basis of the operation of Zigbee networks (mesh networks), it is important to ensure that there are no “funnel”-type distribution situations, in other words two groups of devices isolated from each other with only one mains-powered device between the two groups: in this case, the device between the two groups (funnel) could create communication limits between the two groups of devices because it would find itself repeating all the packets exchanged between the two groups by itself.

This “funnel” type situation in systems with a normal structure of rooms and floors is unlikely, but should it unavoidably occur, it is recommended to evaluate the addition of one or more mains-powered devices in the vicinity of the single device located in the “funnel” area. In any case, should any doubts arise we suggest you contact Gewiss technical support.

#### **Initial System Configuration (commissioning):**

- It is strongly recommended that the battery sensors are joined to the Zigbee network one at a time after inserting all grid-powered devices.
- it is strongly recommended that “ECO connected 4-command push-button panels” are joined to the Zigbee network only after inserting all grid-powered devices.

The push-button panels are bound (for the purposes of signal repeating) to the powered devices (routers) closest to it at the time of configuration; as such, if the push-button panel is used at an excessive distance from these, the signal could be too weak and the commands would not reach the destination devices.

## 14. FIRMWARE UPDATE

The firmware of the individual devices making up the Smart Home system can be updated via the app. The new firmware versions are made available by Gewiss via the Internet connection. New firmware versions are generally released to solve malfunctions, and less frequently to introduce new functions. It is therefore recommended to periodically check whether new firmware versions are available and to update as a consequence. If an update is important, it will be pushed by Gewiss.

As mentioned, it is possible to update the firmware via the Home Gateway App, but before starting the update, ensure that the devices involved are correctly powered and that the power supply will not be interrupted during the update process. During the update, the system will continue to function. Bear in mind that updating of the individual devices could take up to 45 minutes to successfully complete.

### NOTES:

- In order to update battery devices, they will need to be woken up. Without waking them up, the update procedure cannot be started. It is possible to wake up battery devices from the app, by opening the right menu, selecting "**Manage the home**", selecting "**Rooms and devices**", clicking on the room where the device is located, and finally clicking on the [battery](#) device (page 32 Sec. 8). On the device configuration page you will find the "**Reactivate**" button which will allow you to wake up the device.
- During system commissioning, if the firmware of the gateway is obsolete, the Home Gateway App itself will request that you perform an update before continuing with the subsequent commissioning phases.

## 15. DIAGNOSIS

The Home Gateway App offers a dedicated diagnostics section in which you can check:

- The quality of the Wi-Fi network
- Restore devices

To start the **network quality check**:

Select **"Technical"** → **"Diagnostics"** → **"Wi-Fi network status"** → **"Start"**

**Restoring devices:** allows resetting (forced overwrite) of the configuration of a device or all devices present in the system: this function is useful when (e.g. in the case of poor internet connection) inconsistencies and/or discrepancies between the behaviour of the devices and the display of their status on the app occur.

To start the restore process for the devices:

Select **"Technical"** → **"Diagnostics"** → **"Restore devices"**

## 16. FAQ

The Home Gateway App offers a frequently asked questions section where you can find information on managing the system, using the app, and troubleshooting for some of the most common problems you are likely to encounter with your system.

### **HOW CAN I DELETE A USER FROM THE SYSTEM?**

There are three types of users: guest, administrator and installer. Administrator and installer users can delete other users from the **“Manage users”** page: click on the waste basket to the right of the user's name.

Administrator users can disable installer users without deleting them.

### **CAN THE INSTALLER WORK ON THE SYSTEM REMOTELY?**

Yes, the installer can make interventions on the system as regards all configurations or actions not requiring a physical action on the system devices. For this to be possible, installers must be enabled (see [User Profiles and Access Permissions](#) - Page 34 Sec. 11.1).

### **IS IT POSSIBLE TO UPDATE THE SYSTEM?**

All devices in the system, apart from the Home Gateway, can be updated. There is a dedicated section in the Home Gateway App. Select **“Manage the home”**, then **“Updating the devices”**: on this page it is possible to check which updates are available and decide which to run. For further information, see the [FW Update](#) chapter (Page 53 Sec. 14)

### **HOW CAN I KNOW IF THE HOME GATEWAY WAS DISCONNECTED FROM THE NETWORK?**

Every time the Home Gateway is disconnected from the network (and then reconnects), a notification is shown on the app. Check the **“Notifications”** page on the app.

### **IN THE EVENT OF A MALFUNCTION WITH THE HOME GATEWAY, IS THE SYSTEM CONFIGURATION LOST?**

By contacting Gewiss technical support it is possible to recover the system configuration and reproduce it on the new Home Gateway.

### **IS IT POSSIBLE TO INTEGRATE THIRD-PARTY DEVICES IN THE SMART HOME SYSTEM?**

Check the list of compatible devices on the GEWISS website.

### **IS IT POSSIBLE TO CHECK THE STATUS OF A DEVICE WHICH IS PART OF THE SYSTEM REMOTELY?**

The dashboard of the Home Gateway App allows you to check the status of any device in the system.

### **HOW CAN YOU DELETE A DEVICE THAT WAS ADDED BY MISTAKE?**

It is always possible to delete a device which is part of the system by selecting **“Manage the home”**, then **“Rooms and devices”**, the room containing the device you wish to delete, select the device to delete, scroll down and click on **“Delete device”**.

### **WHAT IS THE MAXIMUM DISTANCE BETWEEN A DEVICE AND ITS AUXILIARY?**

The maximum wired distance is 50 metres (see the [Maximum Connection Length](#) chapter - - Page 28 Sec. 6.2).

### **HOW MANY SHIFT FUNCTIONS CAN I HAVE ON AN EGO SMART PLATE?**

The maximum number of SHIFT functions which can be configured for an EGO SMART plate depends on the number and type of smart devices installed in it. The smart devices can have one or two channels available. The maximum number of SHIFT functions which can be configured is equal to the sum of all these channels.

### HOW DO THE MESSAGES ON THE EGO SMART PLATE FUNCTION?

It is possible to receive different types of messages on the EGO SMART plate:

- Scene activation messages
- Alarm messages from sensors installed in the system
- Messages relating to parameters configured in the system

These messages scroll along the LED matrix of the plate and are associated with a particular colour depending on the type of message being displayed.

For the list of messages and alarms which can be displayed by the plate, see the [Push Notifications – Notifications and Alarms](#) chapter - Page 34 Sec. 11.2).

### HOW CAN YOU SILENCE THE NOTIFICATIONS ON THE EGO SMART PLATE?

When the EGO SMART plate flashes and its LED matrix displays a scrolling message, a notification or alarm has been received from the system. To halt the display of this message, simply cover the sensor on the front part of the plate itself for a few seconds. This action will silence all the EGO SMART plates on which the notification or alarm is being displayed.

### WHERE DOES THE EGO SMART PLATE RECEIVE TEMPERATURE INFORMATION FROM?

The plate receives this information from devices which are able to take this measurement.

### IS IT POSSIBLE TO VIEW MULTIPLE ALARMS ON THE EGO SMART PLATE?

The plate allows you to view one notification at a time: the last message received will therefore always be shown.

### IF I BREAK A BUTTON ON AN AUXILIARY INPUT, WILL THIS LEAD TO LOSS OF THE ASSOCIATED FUNCTION?

Simply replace the button with a new one in order to continue using the associated function.

### HOW CAN I RECOVER CONFIGURATIONS IN THE EVENT OF A DEVICE BREAKING?

Most of the ChoruSmart range of devices contain the “**Replace device**” option on their details page. Run this guided procedure to replace a device without losing the functions configured with the previous device.

### FAILURE TO RECEIVE PUSH NOTIFICATIONS EVEN FOLLOWING ACTIVATION

In order to receive system notifications such as warnings, badges etc. you need to have consented during configuration of the app. If not, enabling push notifications in the “**Manage notifications**” menu will not have any effect.

### HOW DO YOU MANAGE THERMOSTAT PROGRAMMING?

Using the “**Programming**” function of the Home Gateway App it is possible to create weekly programming. This will be saved on the cloud and used by the thermostat. For further information, see the [Timer thermostat function](#) chapter (Page 26 Sec. 5.2.2).



Punto di contatto indicato in adempimento ai fini delle direttive e regolamenti UE applicabili:

Contact details according to the relevant European Directives and Regulations:

GEWISS S.p.A. Via A.Volta, 1 IT-24069 Cenate Sotto (BG) Italy tel: +39 035 946 111 E-mail: qualitymarks@gewiss.com

According to applicable UK regulations, the company responsible for placing the goods in UK market is:

GEWISS UK LTD - Unity House, Compass Point Business Park, 9 Stocks Bridge Way, ST IVES

Cambridgeshire, PE27 5JL, United Kingdom tel: +44 1954 712757 E-mail: gewiss-uk@gewiss.com



**+39 035 946 11**  
8:30 - 12:30 / 14:00 - 18:00  
lunedì - venerdì / monday - friday



[www.gewiss.com](http://www.gewiss.com)

