

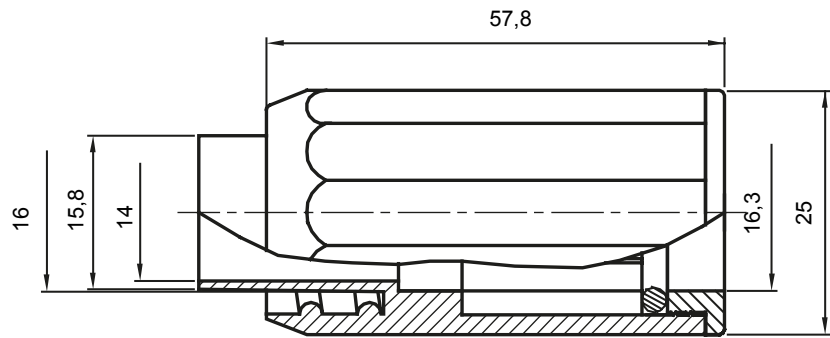

Routing components for rigid protective conduits with IP40 and IP67 protection degree.

Colour	Grey RAL 7035	IP degree	IP65
Conduits Ø (mm)	16	Sheath Ø (mm)	16
Type of material	Halogen free in compliance with EN 50642	Electrocod	21221

DIMENSIONAL

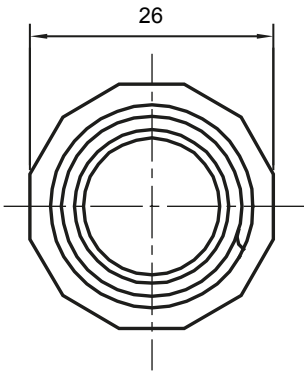

TECHNICAL SYMBOLOGY

IP

HF
HALOGEN FREE

IP65

STANDARDS/APPROVALS

