

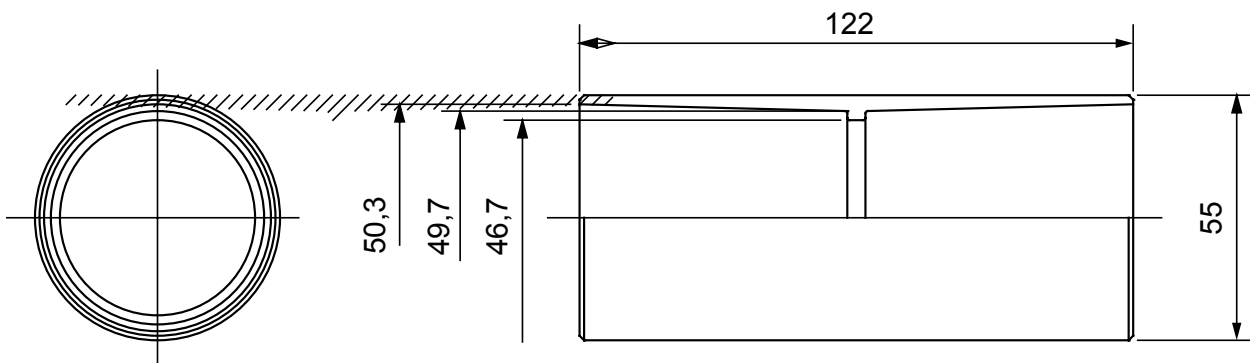

Componente de rutare pentru conducte de protecție rigide cu grad de protecție IP40 și IP67.

Culoare	Gri RAL 7035	Grad IP	IP40
Conducte Ø (mm)	50	Tip material	Halogen free in compliance with EN 50642
Electrocod	21221		

DIMENSIONAL



TECHNICAL SYMBOLOGY

IP

HF
HALOGEN FREE

IP40

STANDARDS/APPROVALS

