

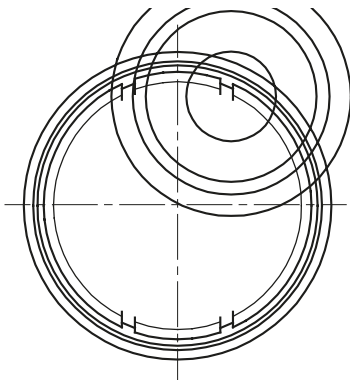

Componente de rutare pentru conducte de protecție rigide cu grad de protecție IP40 și IP67.

Culoare	Gri RAL 7035	Caracteristici	-
Pentru cabluri Ø (mm)	9-12	Electrocod	21221



DIMENSIONAL

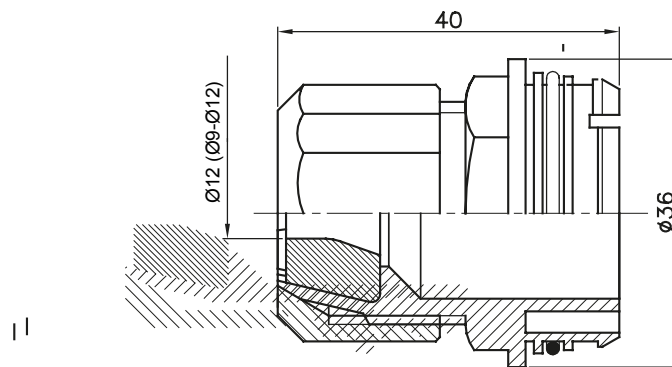

STANDARDS/APPROVALS

