

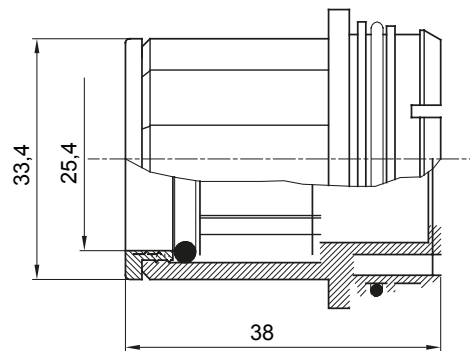

Componente de rutare pentru conducte de protecție rigide cu grad de protecție IP40 și IP67.

Culoare	Gri RAL 7035	Caracteristici	-
Conducte Ø (mm)	25	Electrocod	21221

DIMENSIONAL

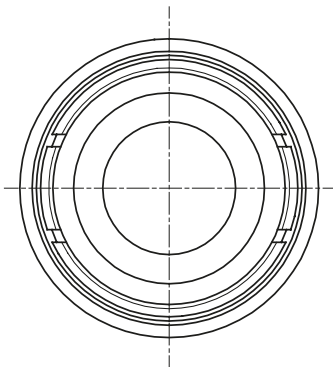

STANDARDS/APPROVALS

