



I-CON wallboxes are JOINON solutions designed to integrate into private and semi-public scenarios in compliance with the international standard IEC 61851-1 ed. 3. They feature an elegant and compact design, special "one-hand charge" functionality and the presence of a vandal-proof socket, IP55 degree combined with IK10-certified mechanical resistance, full connectivity to support the dedicated JOINON App for a complete and easy charging control, intelligent load management and energy produced by any photovoltaic panels (also in Master/Slave mode), and different installation options: wall, recessed or floor.

<b>INPUT</b>		- Socket/Connector Nr. (Type)	1 (Type 2 connector with 5 mt. cable)
Terminal blocks	5 x 10 mm <sup>2</sup>	Charging activation	Free access
Rated current	16 A	Human Interface	RGB Led
Total power	11 Kilowatt	Connectivity	No
<b>OUTPUT</b>		<b>MECHANICAL FACTS</b>	-
Rated voltage	400 V	Mounting and installation	Wall mounting (floor mounting with support)
Current supplied (max)	16 A	Colour	Dark grey
Maximum current	11 Kilowatt	Material	Thermoplastic (Post-industrial origin)
Thermal-magnetic protection	Currently not present	External treatments	No
Type of residual current protection	Currently not present	IP degree	IP55
Power meter	Currently not present	Mechanical resistance	IK10
DC Leakage check	Yes	Operating temperature	-25 +50 °C
(Auto)restart electrical protections	Currently not present	Customizations	Yes (front)

### DIMENSIONAL

40

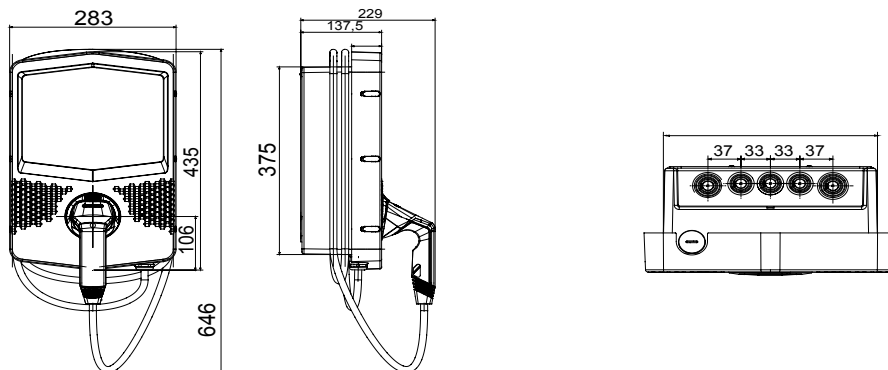

### TECHNICAL SYMBOLOGY

**IP**      **IK**

IP55

IK10

### STANDARDS/APPROVALS

