

45deg Horizontal Bend Wire Mesh Cable Trays, HDG, Wire Diameter: 4 mm, Height: 35 mm, Width: 100 mm

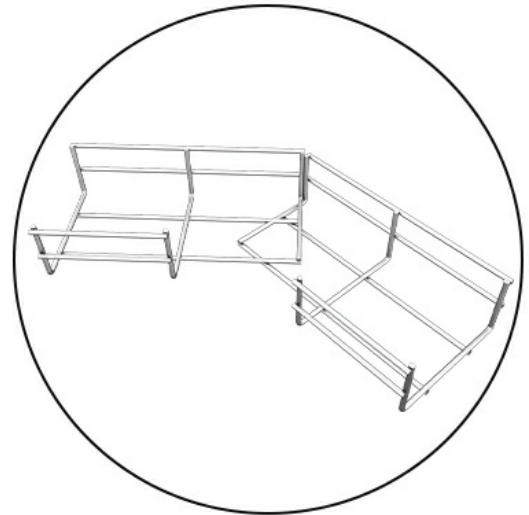
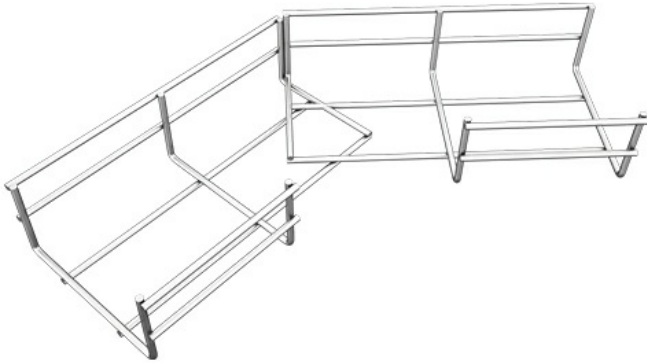

Description

The cable systems' accessories offer to the entire cable system both, functionality and design advantages. Any of the accessories used is better and safer against cable slipping from the run while pulling and using, or cable damaging as may happen for on-site made accessories. Total versatile and certified system, gives the installation a high speed and quality.

Manufactured from different steel types and with different coatings, as per the project requirements and designation.

Dimensions

Thickness	4
Width	100.0
Height	35.0
Length	
Weight	0.21
Finish	HDG

The above design is only a sample of the options available, for reference purposes only. Our policy of continuous improvement may result in a change of specifications without notice. If any discrepancies might be between the data sheet values and standards, we reserve the rights to make technical changes. Our company will not be held responsible, as all or any of pictures, drawings, weights and dimensions details or other elements in this document are only indicative and must not be considered contractual. Contact our sales team for other specifications or custom made products.