

 Deutsche  
 Qualität  
 Garantiert



120

HALF  
CELLS

210  
mm

CELL  
SIZE



LID  
RESISTANT



PID  
RESISTANT



SALT CORROSION  
RESISTANT



SAND  
RESISTANT



AMMONIA  
RESISTANT



HIGHLY STABLE  
AND TOUGH

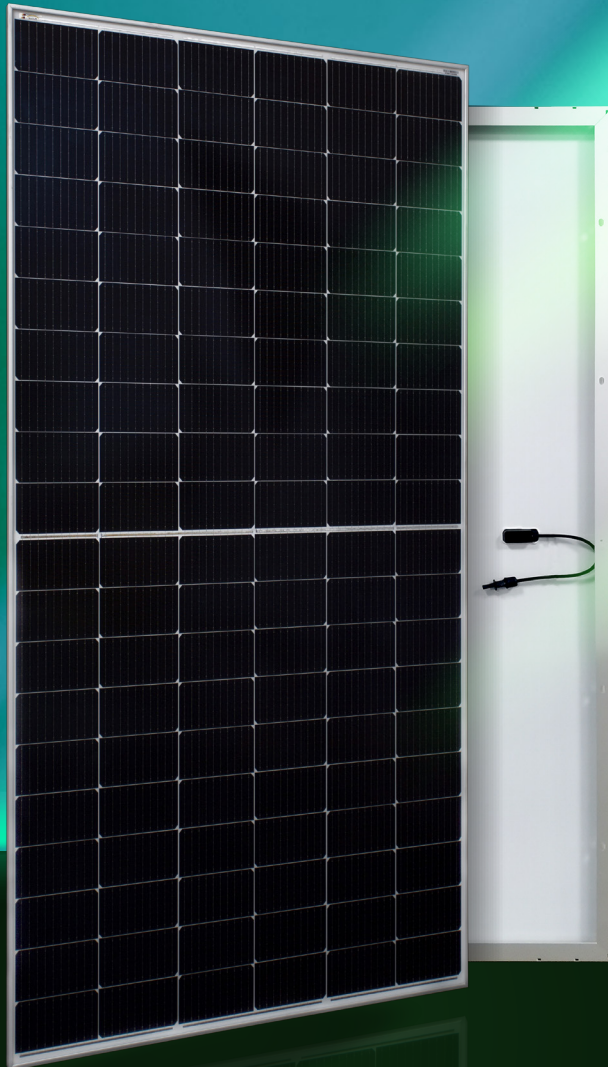

# AURORA

**HIGH** ENERGY YIELD  
RELIABILITY  
DURABILITY

30

years

Performance  
Guarantee

15

years

Product  
Warranty

MONO-CRYSTALLINE PV MODULES  
HALF-CUT CELLS • MONO-FACIAL

## 580W-600W

### AE ME-120 Series



IEC 61215  
IEC 61730  
Regular Production Surveillance  
Type Tested and Monitored

IEC 62716 (Ammonia corrosion)  
IEC 61701 (Salt mist corrosion)  
IEC 60068 (Sand and dust)  
IEC 62804 (PID resistance)

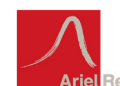

www.ae-solar.com

## AE ME-120 Series 580W-600W

### Mechanical and design specification

Cell type	Gallium-doped Mono c-Si PERC, Half-cut cells, 210 mm
No. of cells	120
Glass	3.2 mm, high transmission, AR coated, tempered
Encapsulation	EVA
Back cover	White backsheet
Junction box	IP 68 rated
Frame	30 mm anodized Aluminium alloy
Cable	1 x 4 mm <sup>2</sup> , 350 mm length or customized
Connectors	MC 4 / MC 4 compatible
Dimension	2171 mm x 1302 mm x 30 mm
Weight	30.5 kg
Hail resistance	Max. Ø 25 mm at 23 m/s
Wind load	2400 Pa/ 244 kg/ m <sup>2</sup>
Mechanical load	5400 Pa/ 550 kg/ m <sup>2</sup>

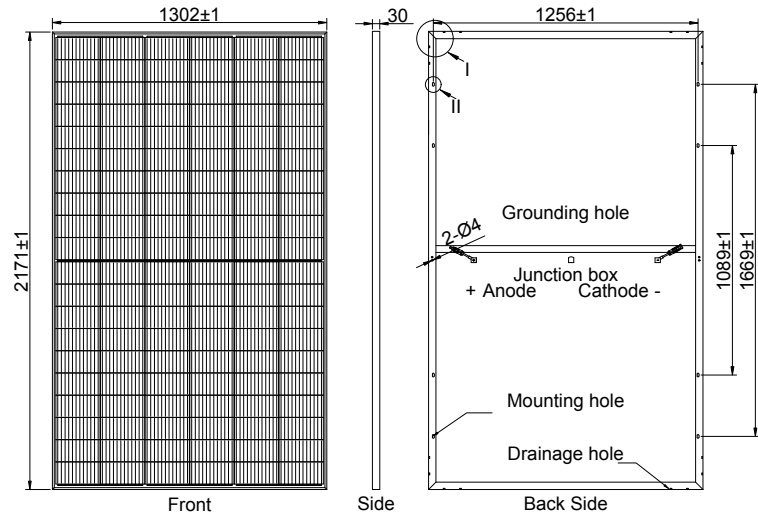

### Packaging information

Packaging configuration	36 pcs / pallet
Loading capacity	612 pcs / 40 HQ
Size / Pallet	1350 mm x 1145 mm x 2310 mm (Upright)
Weight	1136 kg / pallet

### Temperature ratings

Operating temperature	(°C)	-40 to +85
Temp. coefficient of $P_{max}$	(%/°C)	-0.34
Temp. coefficient of $V_{oc}$	(%/°C)	-0.25
Temp. coefficient of $I_{sc}$	(%/°C)	0.04
Nom. operating temp. NOCT	(°C)	43 ± 2

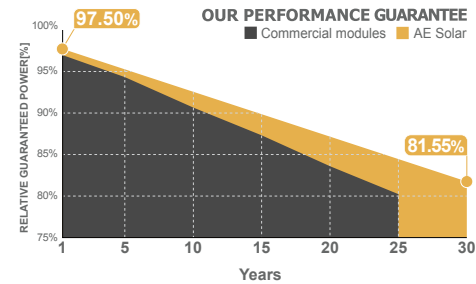
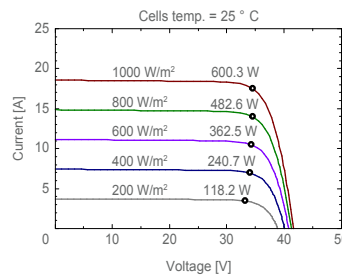
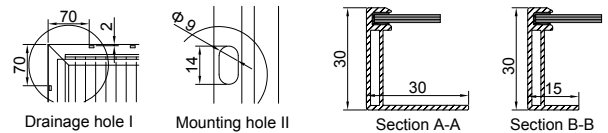

Electrical specifications (STC*):		AE580ME-120	AE585ME-120	AE590ME-120	AE595ME-120	AE600ME-120
Nominal Max. Power	$P_{max}$ (Wp)	580	585	590	595	600
Maximum operating voltage	$V_{MPP}$ (V)	33.60	33.80	34.00	34.20	34.40
Maximum operating current	$I_{MPP}$ (A)	17.26	17.31	17.35	17.40	17.44
Open-circuit voltage	$V_{oc}$ (V)	40.70	40.90	41.10	41.30	41.50
Short-circuit current	$I_{sc}$ (A)	17.81	18.37	18.42	18.47	18.52
Module efficiency	$\eta$ (%)	20.52	20.70	20.87	21.05	21.23
Power tolerance	(W)			0~+5		
Maximum system Voltage	(V)			1500		
Maximum series fuse rating	(A)			30		

\*STC: Standard test conditions (Irradiance 1000 W/m<sup>2</sup>, Cell temperature 25°C and air mass of AM1.5)

Electrical specifications (NMOT*):		AE580ME-120	AE585ME-120	AE590ME-120	AE595ME-120	AE600ME-120
Nominal Max. Power	$P_{max}$ (Wp)	436	440	444	448	452
Maximum operating voltage	$V_{MPP}$ (V)	31.60	31.80	32.00	32.20	32.40
Maximum operating current	$I_{MPP}$ (A)	13.81	13.85	13.88	13.92	13.95
Open-circuit voltage	$V_{oc}$ (V)	37.90	38.10	38.30	38.50	38.70
Short-circuit current	$I_{sc}$ (A)	14.25	14.70	14.74	14.78	14.82

\*NMOT: Normal Module Operating Temperature (Irradiance 800 W/m<sup>2</sup>, Ambient temperature 20°C, air mass of AM1.5 and wind speed of 1 m/s)

The specifications and characteristics contained in this datasheet may deviate slightly from our actual products due to the product developments and uncertainty of measurement devices. The specifications included in the datasheet are subject to change without prior notice.