

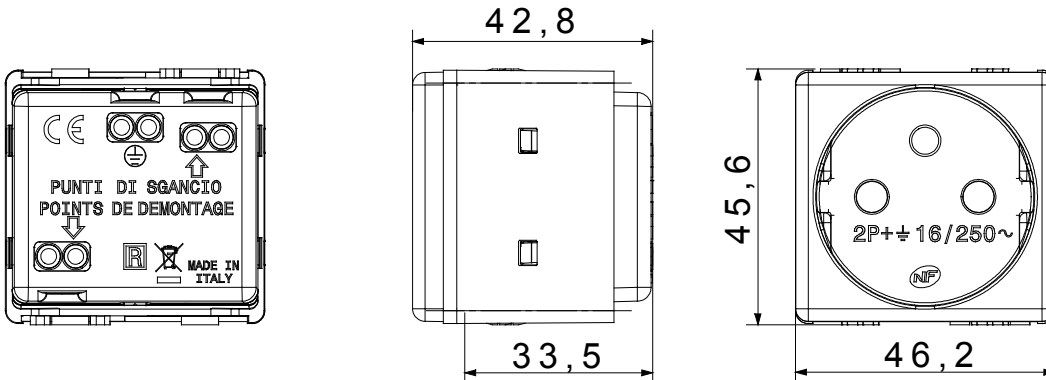

The System modular devices make it possible to create infinite combination between devices and plates, thanks to a complete range that is able to satisfy all design, functional and installation requirements. The range includes commands, socket-outlets, protection, indicators, connectors and devices for the control, safety and comfort of your home.

Categorie	Priză	Descriere	2P+E - 16A
Grup	Pentru liniile alocate	Culoare	Roșu
Tensiune	250 V	Groapă de pământ	-
Standard	Grade franceze	Caracteristici	Cu scuturi de siguranță
Pentru știfturi de conectare	Ø 4 / 4,8 mm	Borne de cablare	Conținut
Tip	-	Standard	IEC 60884-1; NF C 61-314
Rezistența la tensiunea de test	2000 V la 50 Hz timp de 1 minut	Rezistența izolației	>5 MOhm
Comutator de funcționare prelungit (nr. de modificări)	1000 la 2000 V ac cos φ=0,8	Termo-presiune cu bilă	125 °C
Test de încercare cu fir incandescent	850 °C	Prinderea bornei la tracțiunea cablului	> 50 N
Capacitate de strângere borne cabluri torsadate (mm²)	min. 0,75 - max. 2x4	Capacitate de strângere a bornelor cabluri solide (mm²)	min. 0,5 - max. 2x2,5
Nr. Module DE SISTEM	2	Material	Tehnopolimer
Electrocod	0131		

DIMENSIONAL



TECHNICAL SYMBOLOGY



STANDARDS/APPROVALS

