

Culoare	Gri RAL 7035	Material	PP
Conducte Ø (mm)	32	Electrocod	210

DIMENSIONAL

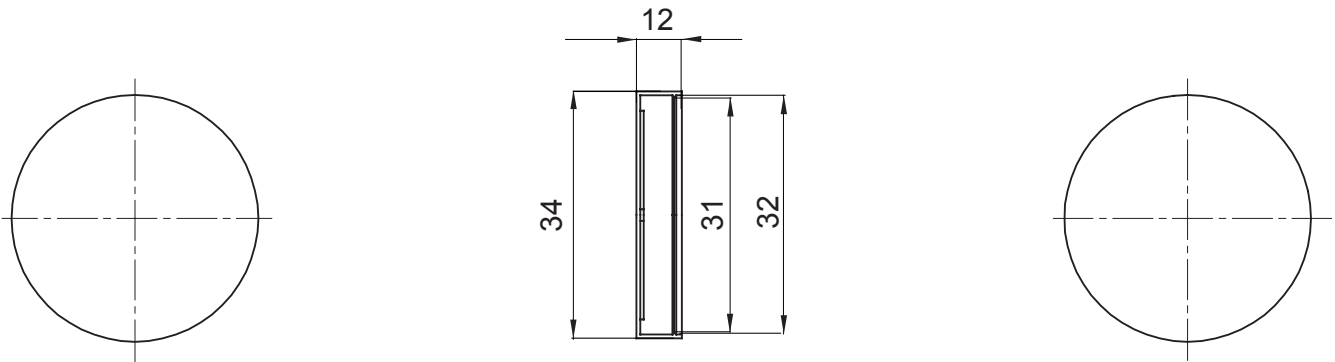

STANDARDS/APPROVALS

