

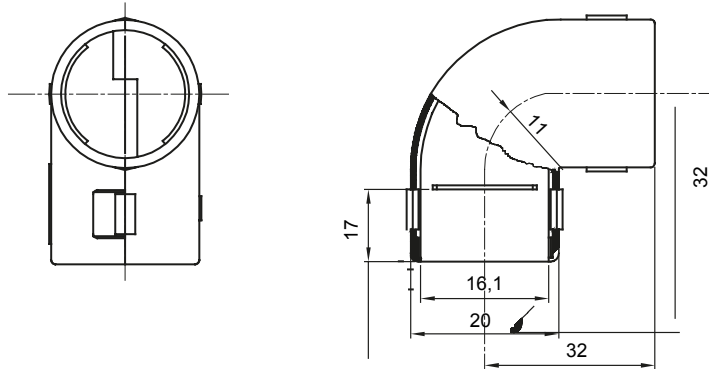

Componente de rutare pentru conducte de protecție rigide cu grad de protecție IP40 și IP67.

Culoare	Gri RAL 7035	Grad IP	IP40
Conducte Ø (mm)	16	Electrocod	21221

### DIMENSIONAL



### TECHNICAL SYMBOLOGY

## IP

IP40

### STANDARDS/APPROVALS

